

RME-ENVESS23A621LOR-01/A (01)

This report cancels and replaces the test report N°RME-ENVESS23A621LOR-01/A, Edition 00

MECHANICAL TEST REPORT

According to the standards:

NF EN 60068-2-6 (2008)

NF EN 60068-2-27 (2009)

Equipment under test:

One CAL23DmA

One CPL 35L

One CNL35LA

One INL35

One CNL40IGH

Company:

LOREME

DISTRIBUTION: Mr REPPERT

Company: LOREME

Number of de pages: 45

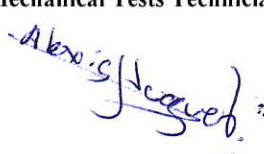
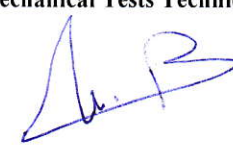
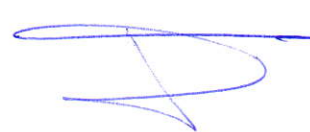
Ed.	Date	Modified Pages	Written by	Technical Verification	Quality Approval
			Name, function and Visa	Name, function and Visa	Name, function and Visa
01	05/04/2023	Refer to lines in the margin	Alexis HUGUET Mechanical Tests Technician 	Benjamin VUGIER Mechanical Tests Technician 	Renaud MOREAU Mechanical Tests Engineer 

Duplication of this document is only permitted for an integral photographic facsimile. It includes the number of pages referenced here above. This document is the result of testing a specimen or a sample of the product submitted. It does not imply an assessment of the conformity of the whole production of the tested sample.

EQUIPMENT UNDER TEST: One CAL23DmA
One CPL 35L
One CNL35LA
One INL35
One CNL40IGH

MANUFACTURER: LOREME

CUSTOMER'S NAME AND ADDRESS:

Company: LOREME

Address: 12, Rue des Potiers d'Etain Actipôle BORNÝ
BP 35014
57071 METZ Cedex 3

Contact: Mr REPPERT

PURCHASE ORDER: N° E230142 AMP

TEST DATES: From 9th to 14th March, 2023

TEST LOCATION: Environne'Tech
49 Boulevard du pré pommier
BOURGOIN-JALLIEU 38300

TESTER: Alexis HUGUET

SUMMARY

1. PURPOSE OF THE TESTS.	4
2. EQUIPMENT SUBMITTED FOR TESTING.	4
3. SPECIFICATIONS SHEET.	5 - 6
3.1. <i>Reference documents:</i>	5
3.2. <i>Reminder of the main criteria of tests:</i>	5
3.2.1. <i>Resonance frequency search, sine vibrations:</i>	5
3.2.2. <i>Endurance, sine vibrations:</i>	5
3.2.3. <i>Shock tests:</i>	6
3.3. <i>Functional control verification:</i>	6
3.4. <i>Representation of standard tolerances:</i>	6
4. EQUIPMENT USED.	7
4.1. <i>Means of tests:</i>	7
4.2. <i>Measurement Equipment.</i>	7
4.3. <i>Tools:</i>	7
5. TEST LOG.	8 - 44
5.1. <i>Z axis:</i>	9 - 20
5.1.1. <i>Test set up for sine vibrations:</i>	9
5.1.2. <i>Sinus vibrations – RFR initial:</i>	10
5.1.3. <i>Sinus vibrations - Endurance:</i>	12
5.1.4. <i>Sinus vibrations – RFR final:</i>	14
5.1.5. <i>Test set up for shocks:</i>	16
5.1.6. <i>Shock tests:</i>	17
5.2. <i>X axis:</i>	21 - 32
5.2.1. <i>Test set up for sine vibrations:</i>	21
5.2.2. <i>Sinus vibrations – RFR initial:</i>	22
5.2.3. <i>Sinus vibrations - Endurance:</i>	24
5.2.4. <i>Sinus vibrations – RFR final:</i>	26
5.2.5. <i>Test set up for shocks:</i>	28
5.2.6. <i>Shock tests:</i>	29
5.3. <i>Y axis:</i>	33 - 44
5.3.1. <i>Test set up for sine vibrations:</i>	33
5.3.2. <i>Sinus vibrations – RFR initial:</i>	34
5.3.3. <i>Sinus vibrations - Endurance:</i>	36
5.3.4. <i>Sinus vibrations – RFR final:</i>	38
5.3.5. <i>Test set up for shocks:</i>	40
5.3.6. <i>Shock tests:</i>	41
6. CONCLUSION.	45

1. PURPOSE OF THE TESTS.

Test purpose was to certify one CAL23DmA, one CPL 35L one CNL35LA, one INL35 and one CNL40IGH under mechanical test conditions.

2. EQUIPMENT SUBMITTED FOR TESTING.

Equipment that must be tested is: one CAL23DmA, one CPL 35L one CNL35LA one INL35 and one CNL40IGH.

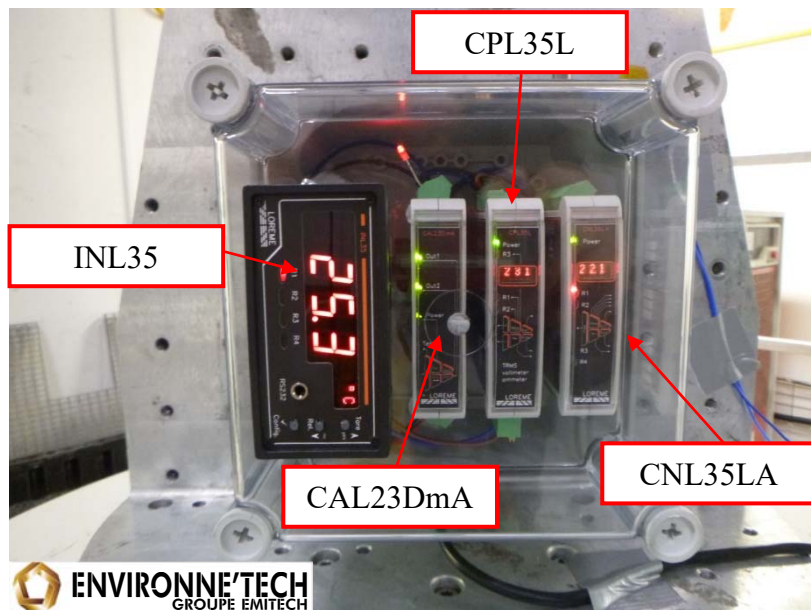

photo 1

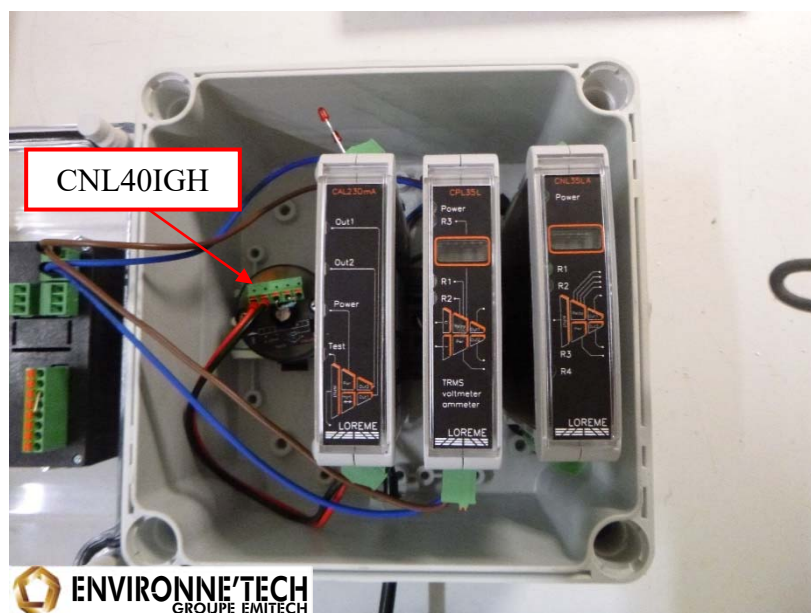

photo 2

The equipment carried the Environne'Tech test number: 23A621.

3. SPECIFICATIONS SHEET.

The tests shall be conducted as per following document and as per *Environne'Tech Offer N°ENVESS-23A621LOR-00V02*.

3.1. Reference documents:

- Environne'Tech Offer N° ENVESS-23A621LOR-00V02
- The standards: **NF EN 60068-2-6 (2008)**
NF EN 60068-2-27 (2009)

3.2. Reminder of the main criteria of tests:

3.2.1. Resonance frequency search, sine vibrations:

- Frequency range: 0.1 Hz to 50 Hz
- Number of axis: along 3 axis
- Control points: P and LVDT
- Level: **25 mm peak from 0.1 Hz to 1 Hz**
0.1g from 1 Hz to 5 Hz
1 mm peak from 5 Hz to 22Hz
2g from 22 Hz to 50 Hz
- Sweep rate: **1 oct/min**
- Number of cycle: 1
- State of equipment: ON

3.2.2. Endurance, sine vibrations:

- Frequency range: 0.1 Hz to 50 Hz
- Number of axis: along 3 axis
- Control points: P and LVDT
- Level: **25 mm peak from 0.1 Hz to 1 Hz**
0.1g from 1 Hz to 5 Hz
1 mm peak from 5 Hz to 22Hz
2g from 22 Hz to 50 Hz
- Sweep rate: **1 oct/min**
- Number of cycle: 5
- State of equipment: ON

3.2.3. *Shock tests:*

- Type: half-sine
- Number of axes: along 3 axes (Ox, Oy and Oz)
- Number of shocks: 3/direction/axis
- Control point: P
- Level: 15g 11ms
- State of equipment: ON



3.3. *Functional control verification:*

A visual inspection and verification test will be performed before, during and after each test by Environne'Tech Company.

The verification consists in seeing that all the LEDs and the displays are lit.

3.4. *Representation of standard tolerances:*

A summary table of graphical representations of normalized tolerances given below:

Type of test	Curve lay-out: Standard tolerances
Sinus vibration	
Shocks	

4. EQUIPMENT USED.

4.1. Means of tests.

Identity	Designation	Brand and Model	Characteristics
MECA 306	Double stem cylinder, double acting	QUIRI HiFi-S A32-100	cylinder, double rod, double acting with hydrostatic bearings, displacement: 100mm, 31kN, 0.1Hz to 200Hz
MECA 283	Hydraulic vibration generator	QUIRI HiFi-S A32-100	displacement: 100mm, 31kN, 0.1Hz to 200Hz static force
MECA 76	Electrodynamic vibrator	LDS V875-640T	35kN ; 5Hz to 2000Hz ; resonance 2200Hz sine: 35kN; 25.4 mmPeak; 1.5m/sPeak; 50gPeak random: 33kNeff; 75geff / impact 1/2sine: 93kN
MECA 648	Electrodynamic vibrator	LDS V8-440 HBT 600	5Hz to 2500Hz ; resonance at 2000Hz ; sine: 57.8kN ; random: 66kN; impact: 1/2sine 198kN

4.2. Measurement Equipment.

Identity	Designation	Brand and Model	Characteristics	Last validity date	Metrological confirmation valid until
MECA 770	Control generator	SIEMENS/LMS SCL2E20V	up to 32 measuring channels - sine, random, shocks, level limitation - 0.5Hz to 5000Hz - analysis 0.5Hz to 40kHz - Test.Lab 13A/17	13/06/2022	13/08/2024
MECA 659	Accelerometer	PCB 393B04	sensitivity: 955.7 mV/g at 160Hz	27/03/2023	27/05/2024
MECA 660	Accelerometer	PCB 3711B1150G	sensitivity: 39.06 mV/g at 160Hz	24/05/2022	24/07/2023
MECA 804	Accelerometer	PCB 353B03	sensitivity: 9.91 mV/g at 160Hz	22/08/2022	22/10/2023
MECA 592	Accelerometer	PCB 356A02	X: 9.72 mV/g, Y: 9.79 mV/g, Z: 9.82 mV/g at 160Hz	25/01/2022	25/03/2023

4.3. Tools.

Tooling is provided by Environne'Tech

5. TEST LOG.

Vibration tests are piloted with the accelerometer P and LVDT, the displacement sensor of the test bench.

P and LVDT each control part of the test as a function of frequency:

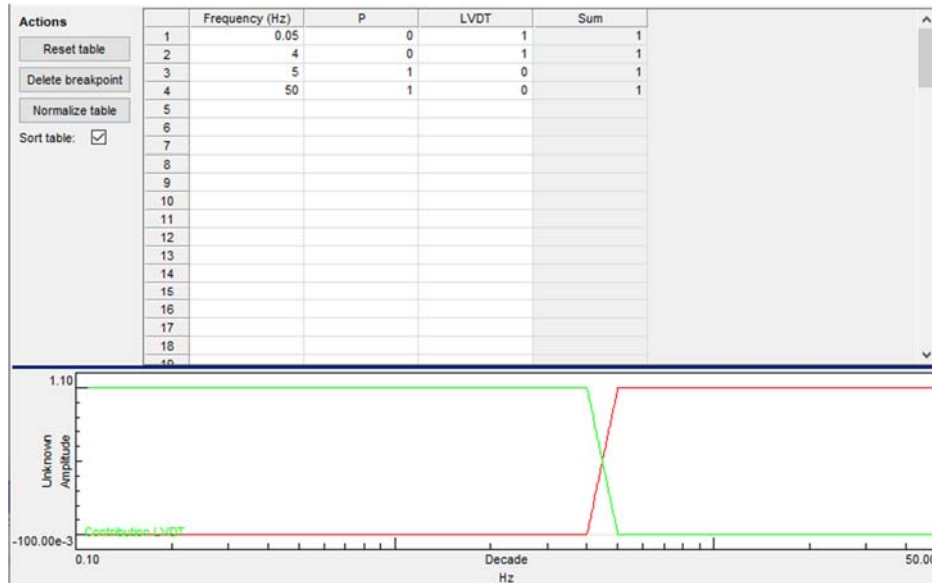

Note : This strategy of piloting is only used for the horizontal axis (Ox and Oy), the tests on vertical axis (Oz) are piloted with only the accelerometer P.

LVDT is the displacement sensor of the test bench, used to control the test in the lowest frequencies (0.1 to 4 Hz).

P is an accelerometer used to control the test in the intermediate frequencies (3 to 50 Hz).

M is a measure accelerometer on the module.

The tests occurred as follows:

Date	Test performed	Axis
10/03/2023	Initial resonance frequency search, sine vibrations	Z
	Endurance, sine vibrations	Z
	Final resonance frequency search, sine vibrations	Z
13/03/2023	Initial resonance frequency search, sine vibrations	X
	Endurance, sine vibrations	X
	Final resonance frequency search, sine vibrations	X
	Initial resonance frequency search, sine vibrations	Y
	Endurance, sine vibrations	Y
	Final resonance frequency search, sine vibrations	Y
	Shock tests	X
Shock tests	Y	
14/03/2023	Shock tests	Z

5.1. Z axis:

5.1.1. Test set up for sine vibrations:

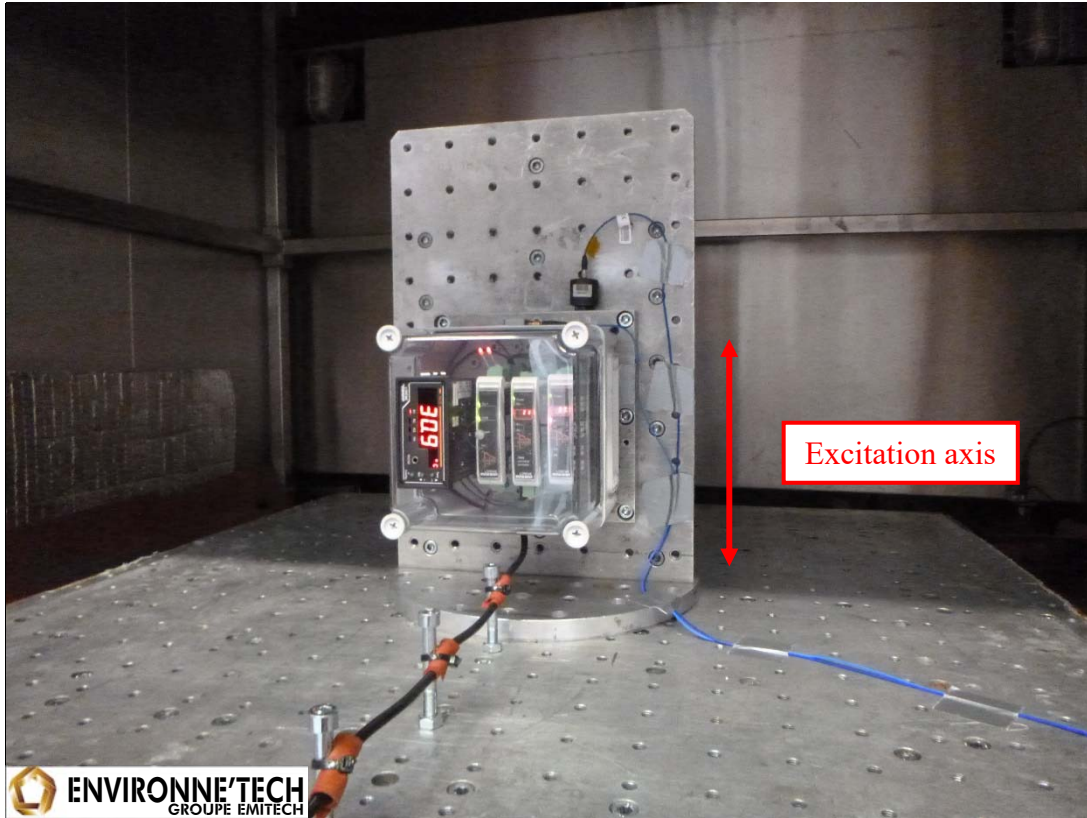

photo 3

LVDT is the displacement sensor of the bench.
Positioning of accelerometers P and M given below:

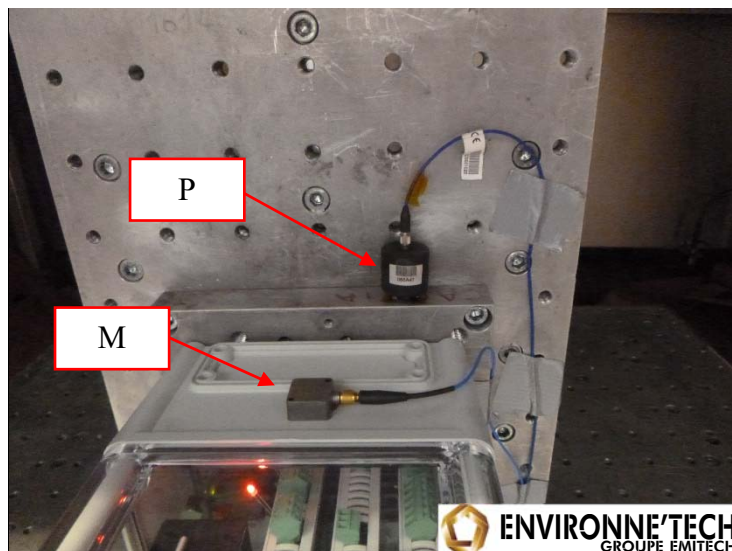
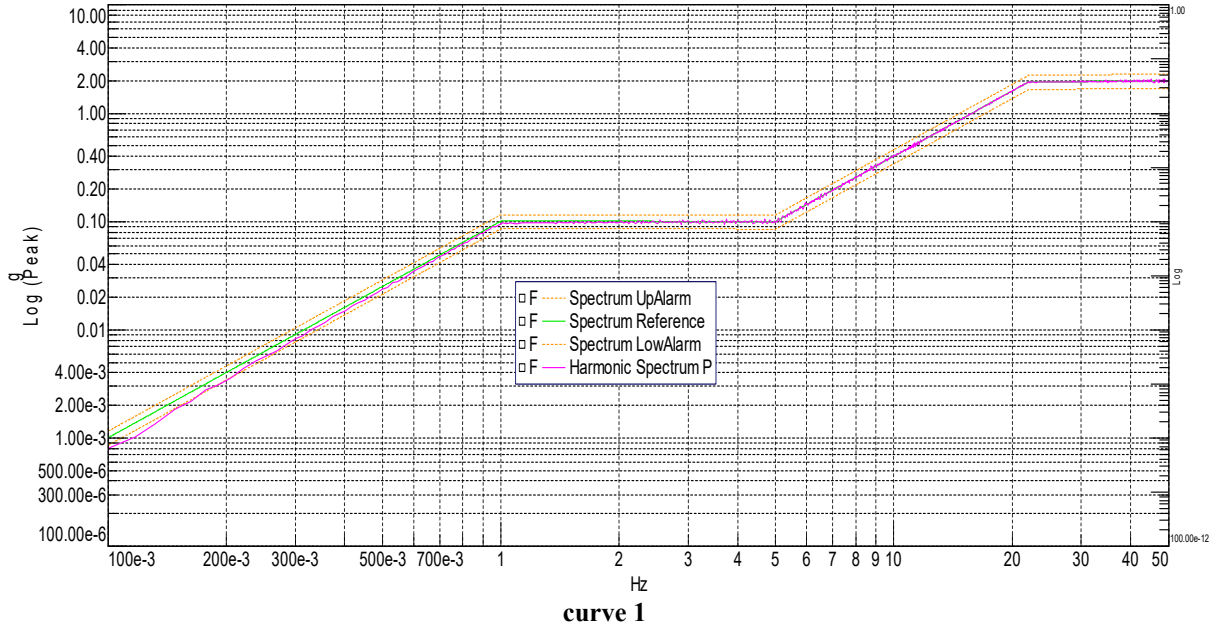

photo 4

5.1.2. Sinus vibrations – RFR initial:

Control curve recorded at test end given below:

Acceleration measurement of P sensor is given below:



Displacement measurement of P sensor is given below:

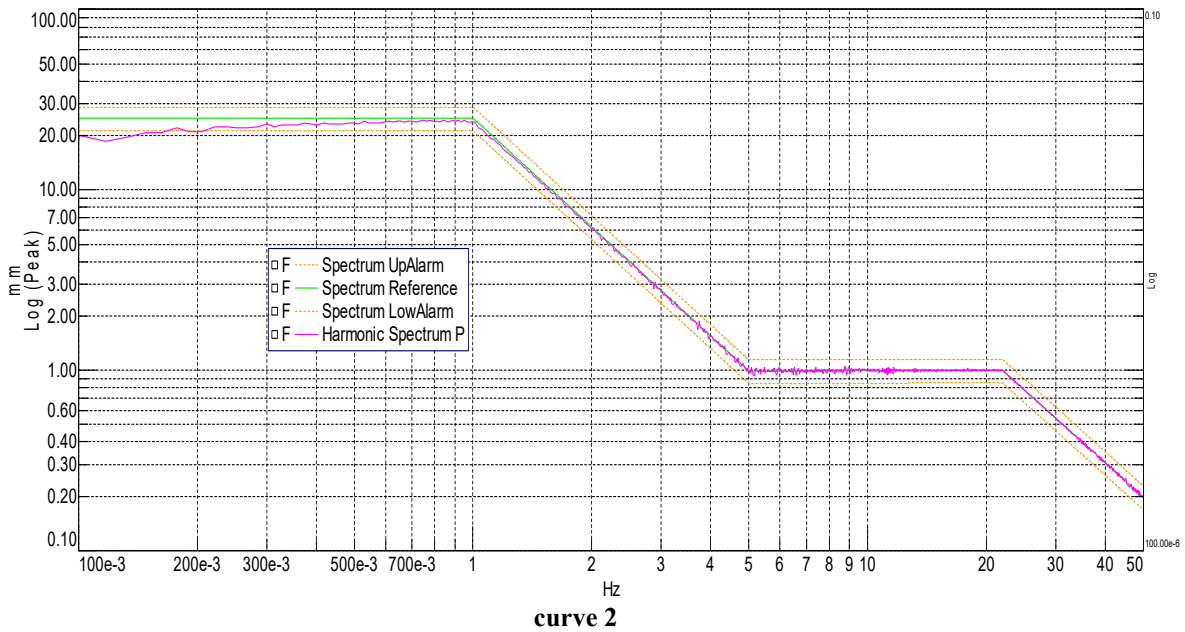

Measurements at M point are given below:

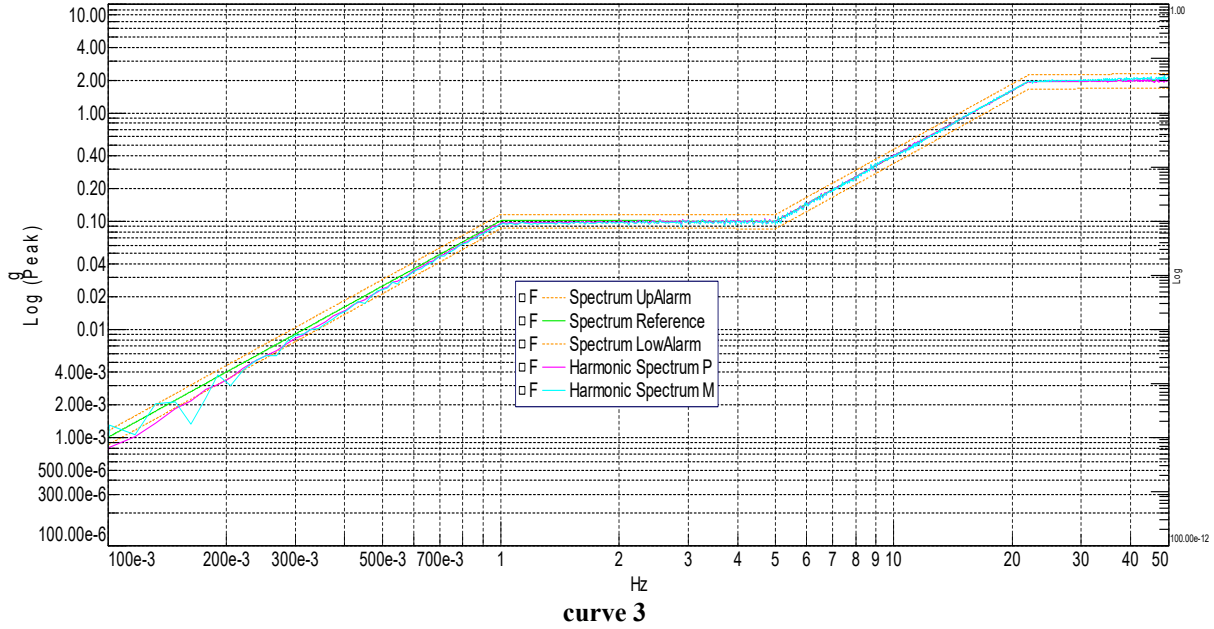

Transfer function at M point is given below:

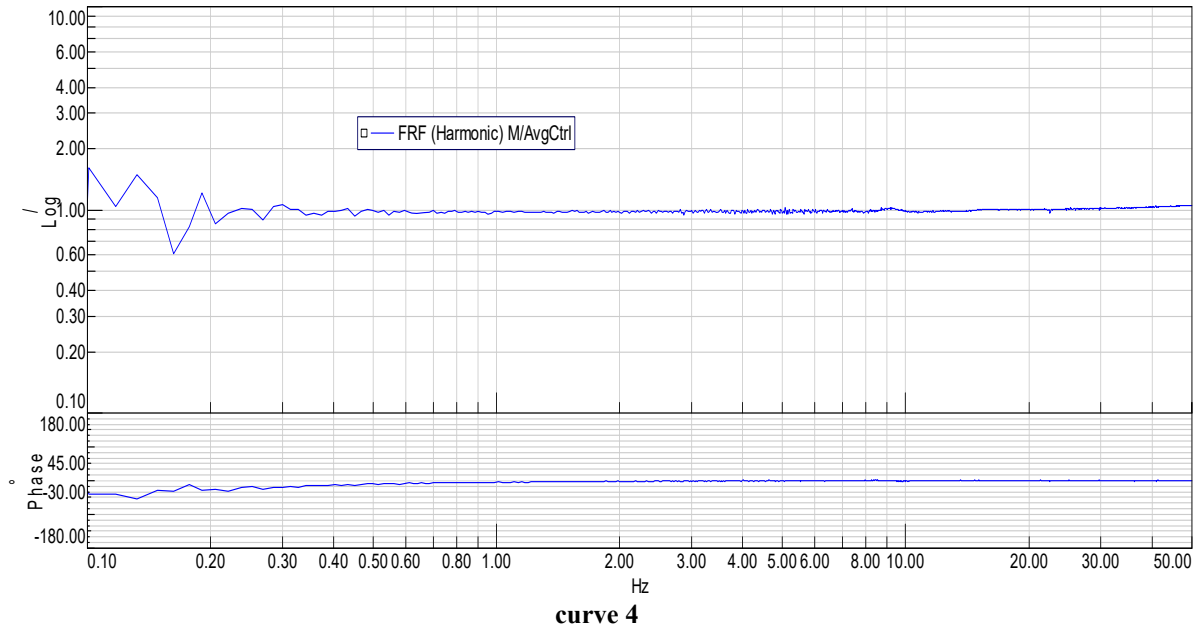

Results: No degradation was observed. There is no resonance frequency.

5.1.3. Sinus vibrations - Endurance:

Control curve recorded at test end given below:

Acceleration measurement of P sensor is given below:

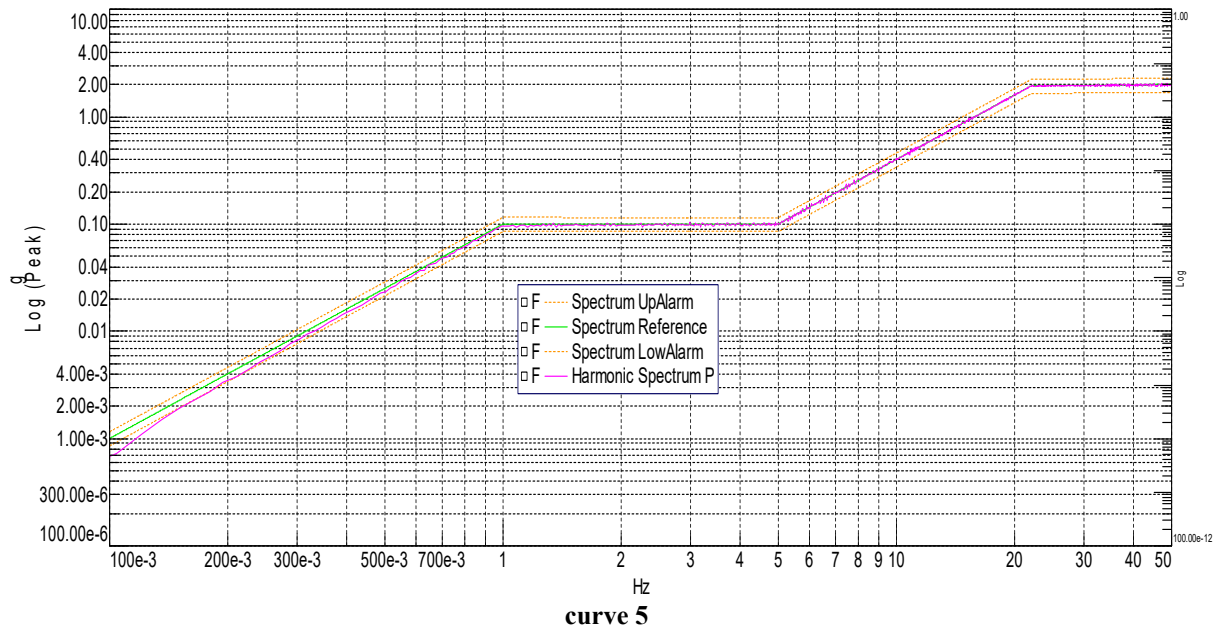

Displacement measurement of P sensor is given below:

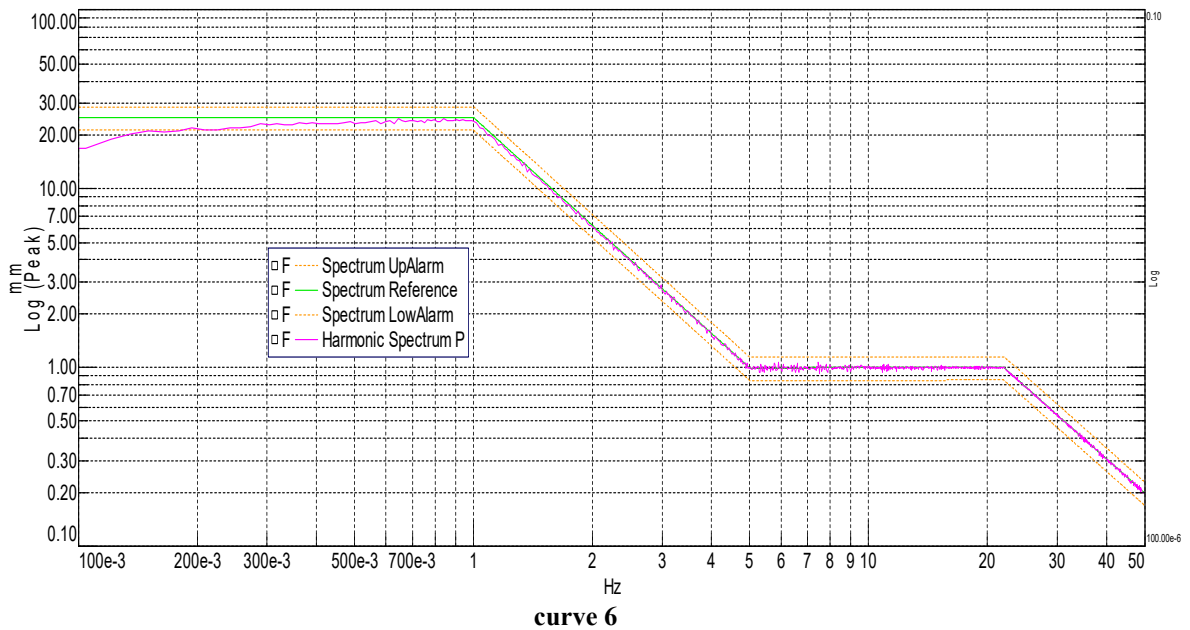

Acceleration measurement of M point is given below:

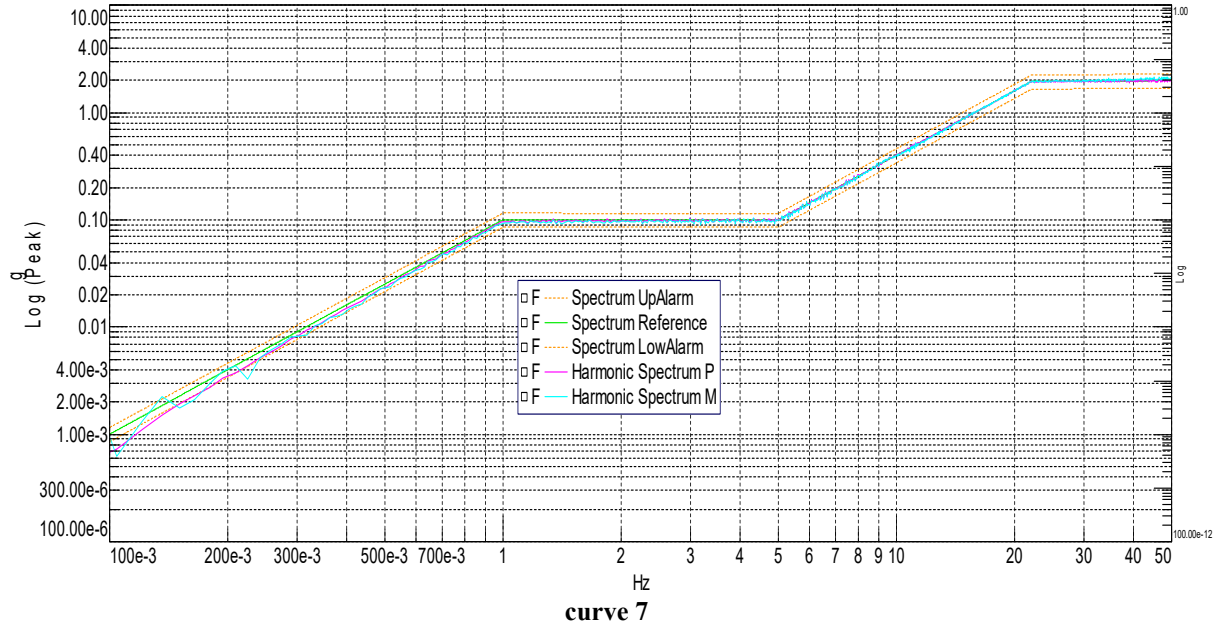

Results: No degradation was observed at the end of the test.

5.1.4. Sinus vibrations – RFR final:

Control curve recorded at test end given below:

Acceleration measurement of P sensor is given below:

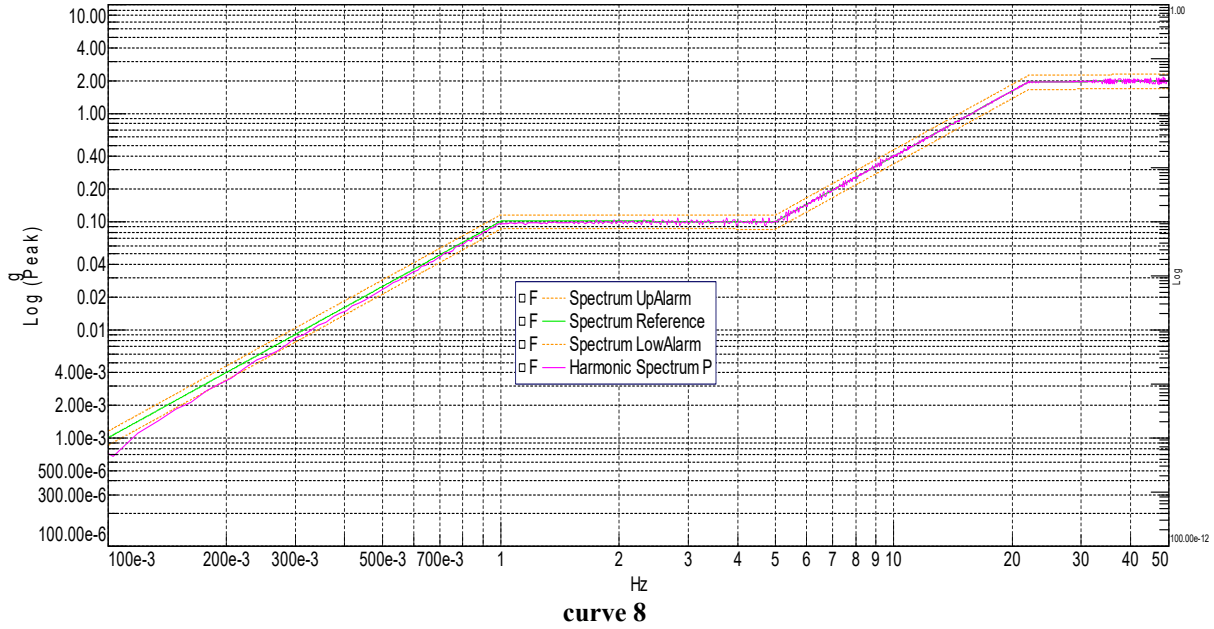

Displacement measurement of P sensor is given below:

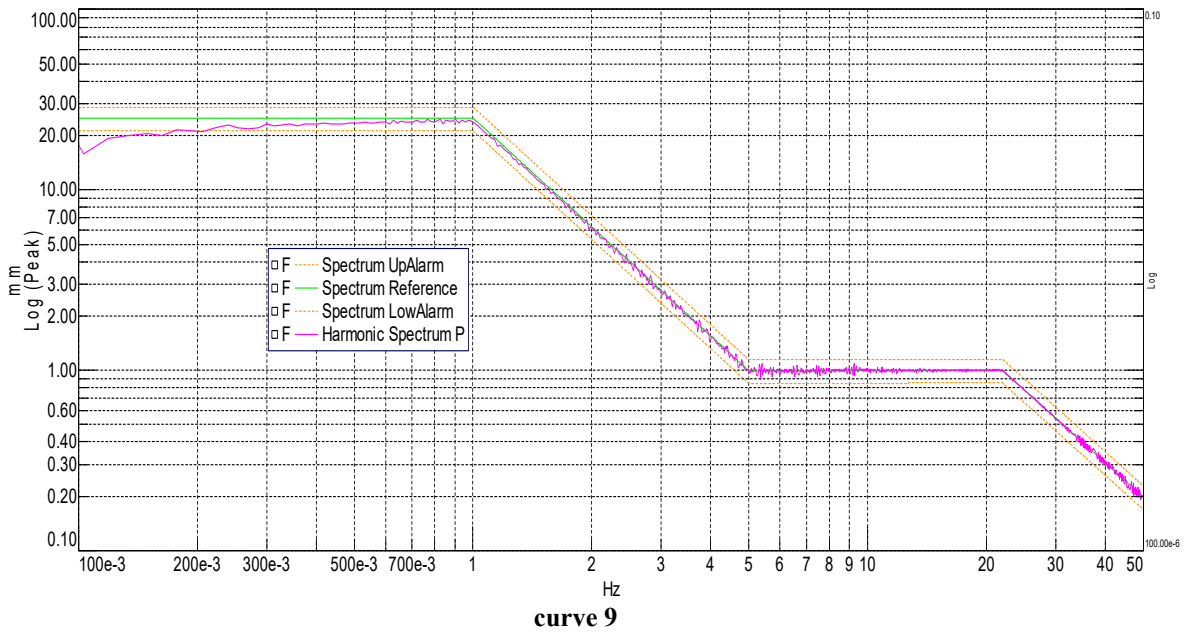

Measurement at M point given below:

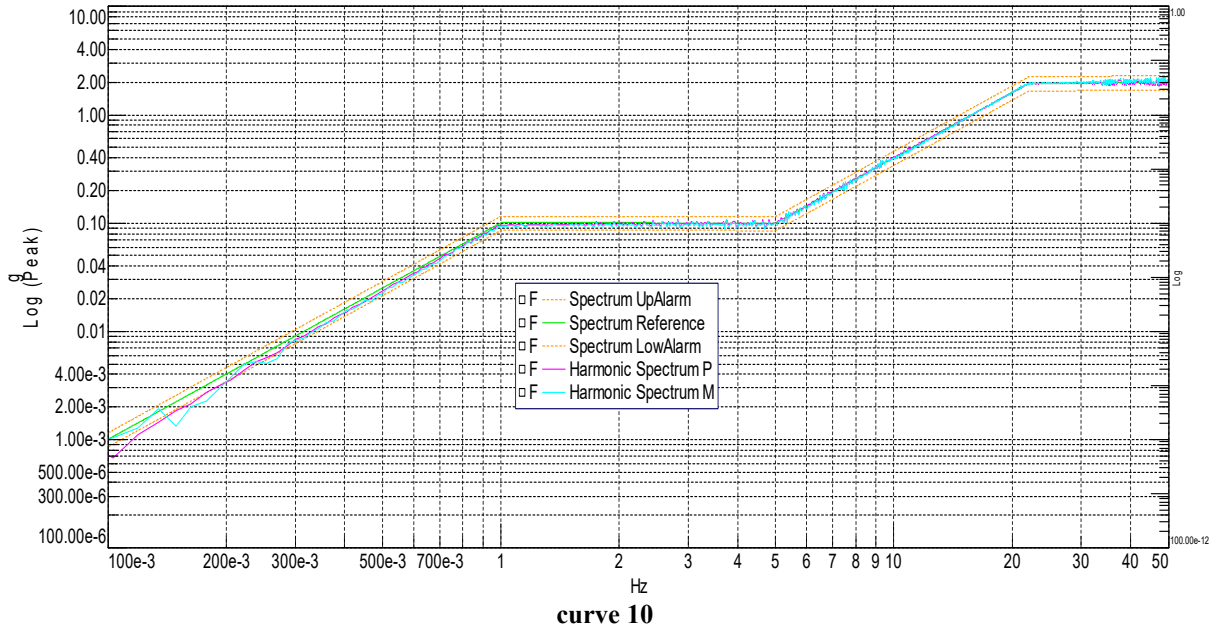

Transfer function at the point M is given below:

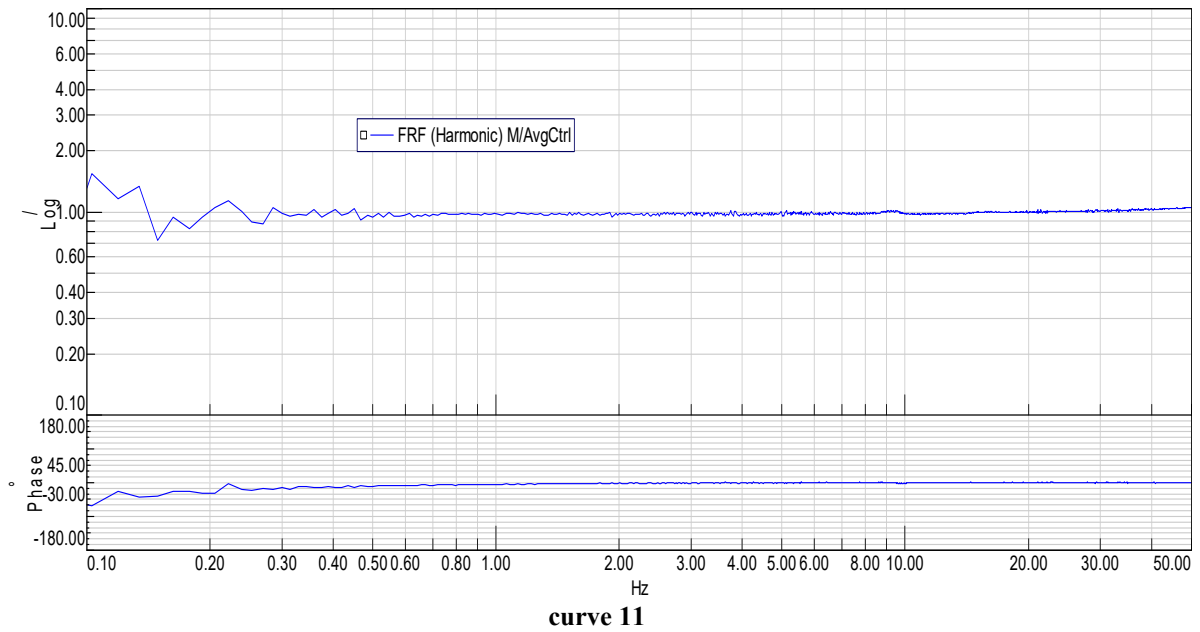

Results: No degradation was observed. There is no resonance frequency.

5.1.5. Test set up for shocks:

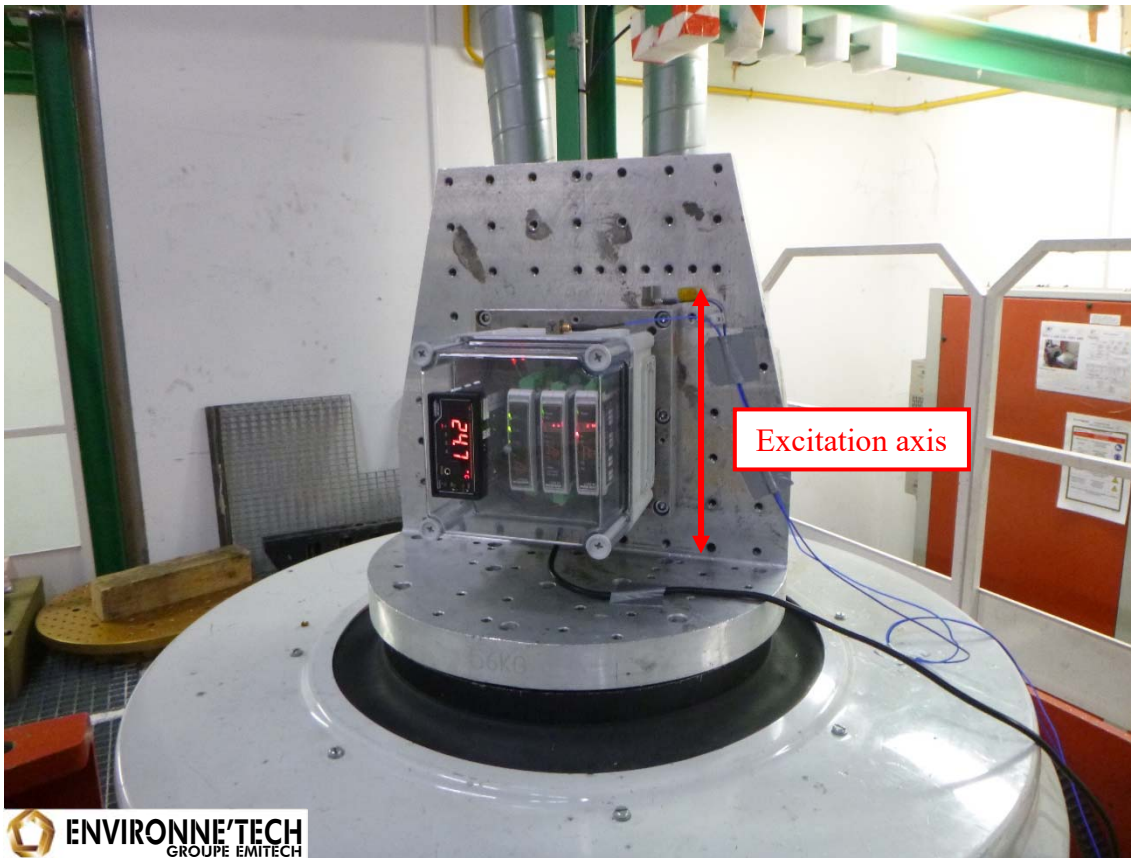

photo 5

Positioning of accelerometer P and M given below:

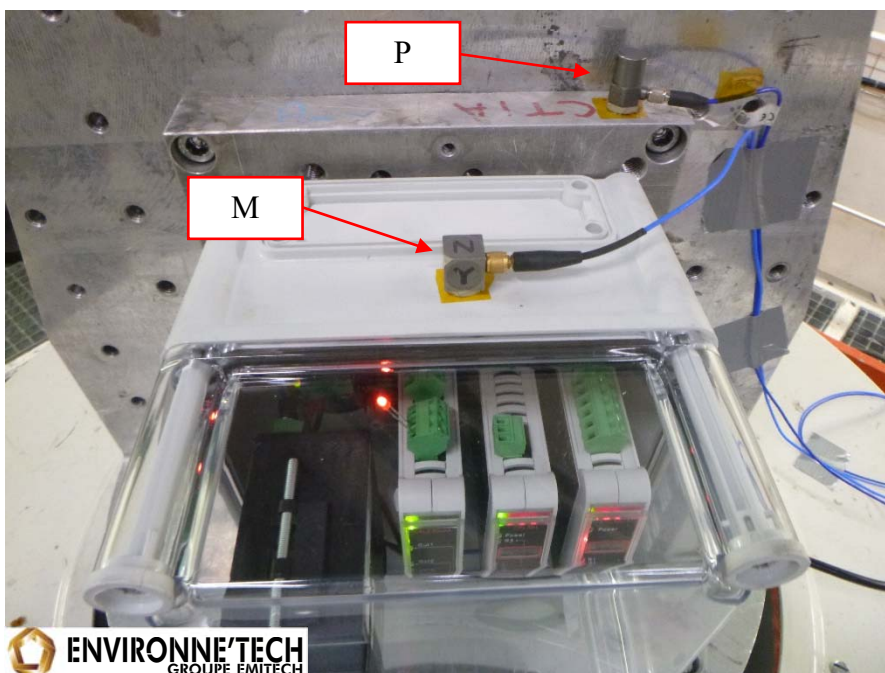

photo 6

5.1.6. Shock tests:

Control was done at P point.

Curves of the third positive shock are given below.

Control curve is given below:

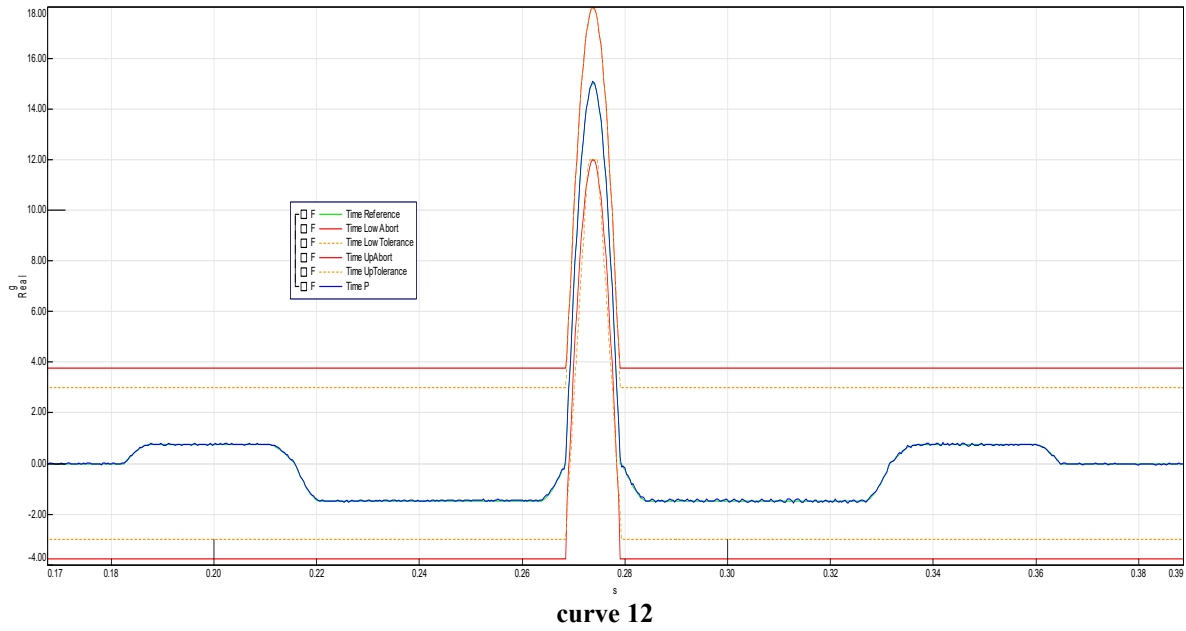

Zoomed control curve is given below:

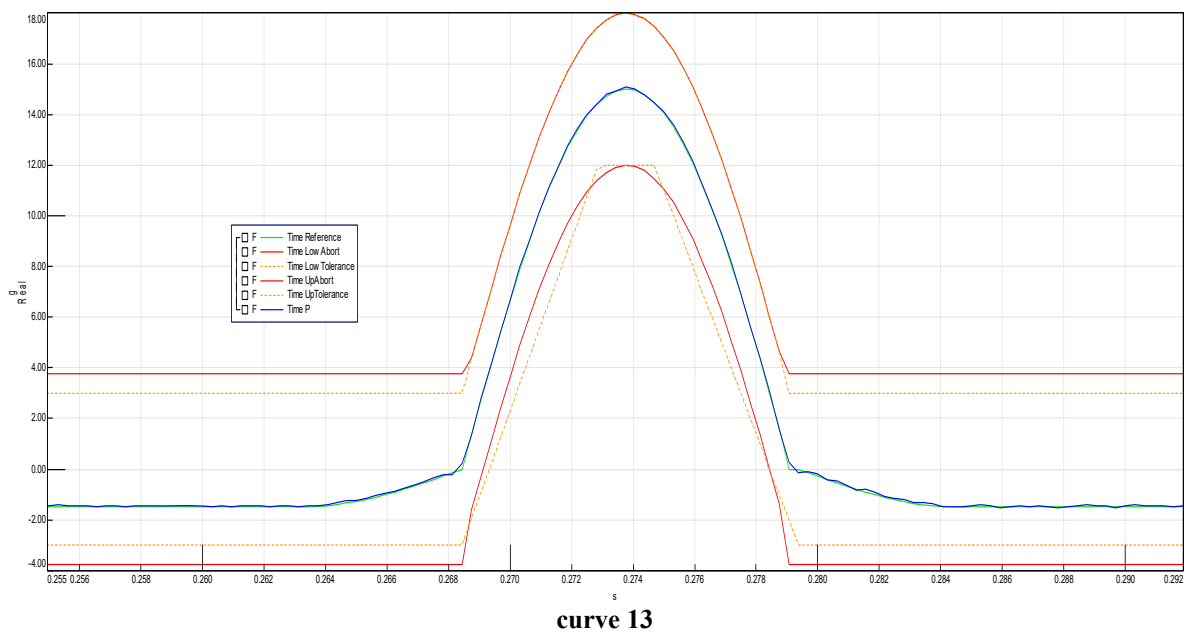

Curves at M point are given below:

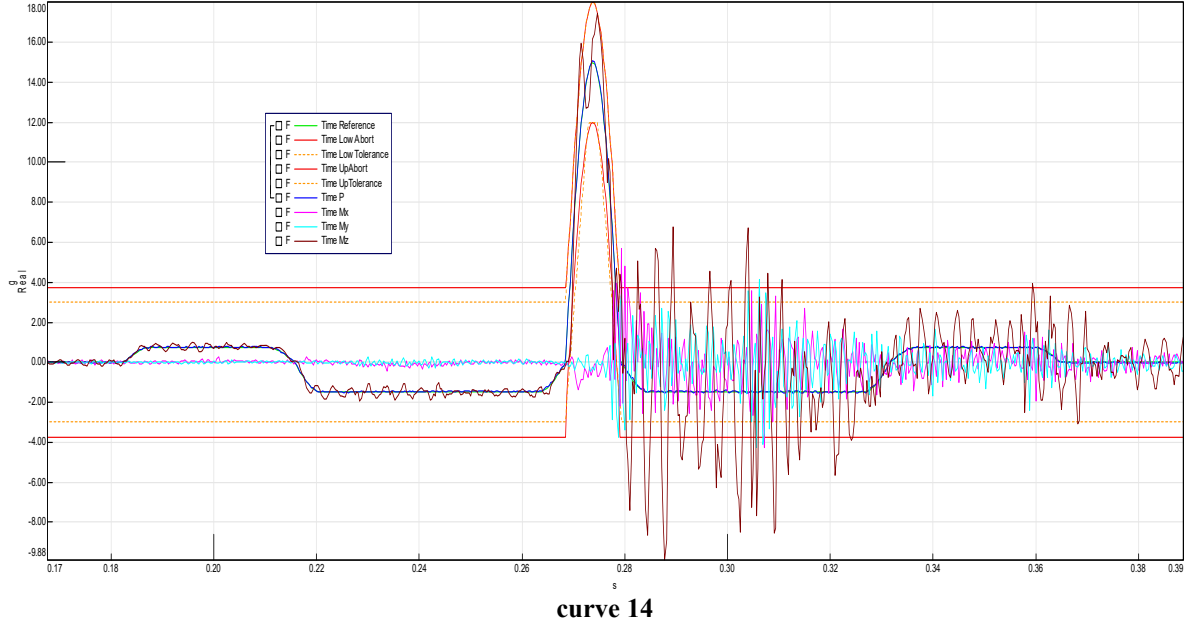

Curves of the third negative shock are given below.

Control curve is given below:

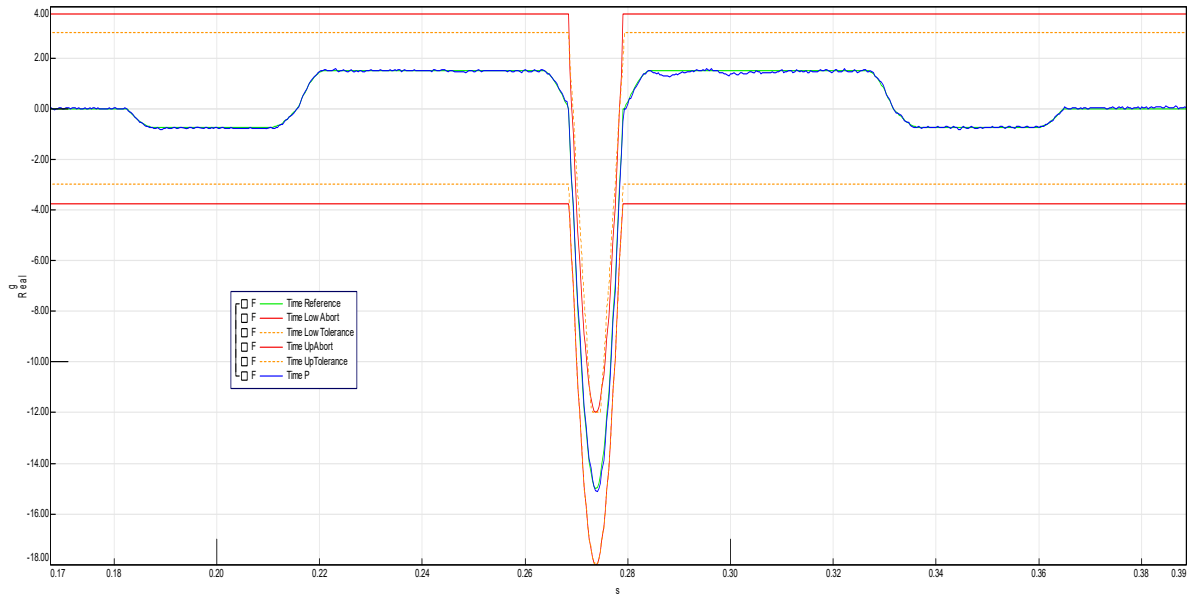

curve 15

Zoomed control curve is given below:

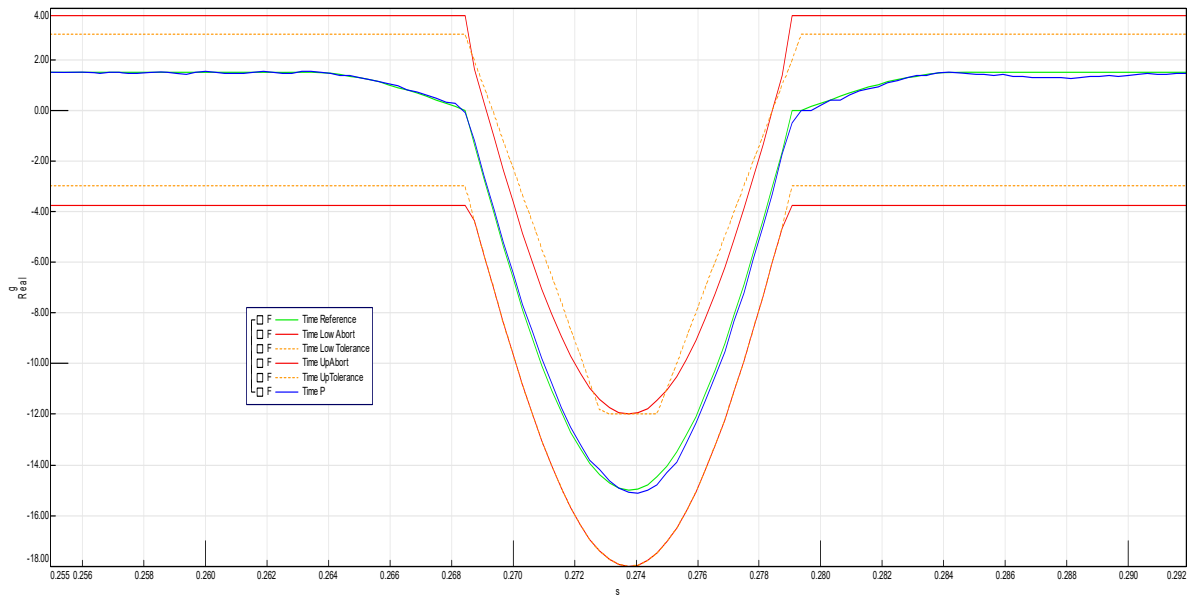

curve 16

Curves at M point are given below:

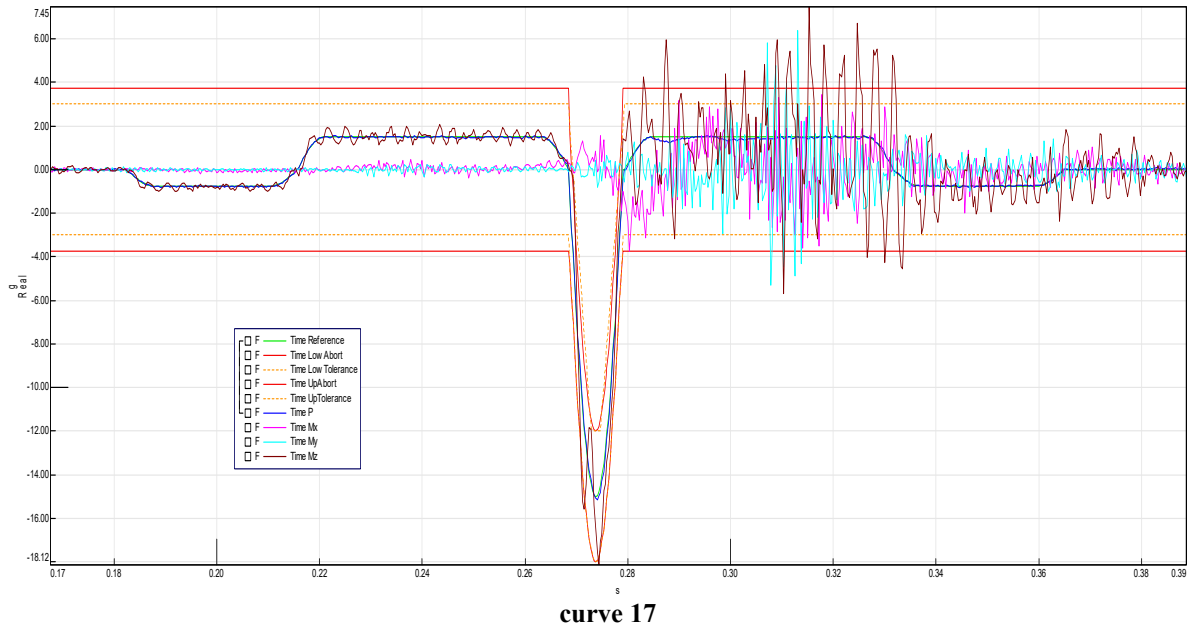

Results: No degradation was observed at the end of the test.

5.2. X axis:

5.2.1. Test set up for sine vibrations:

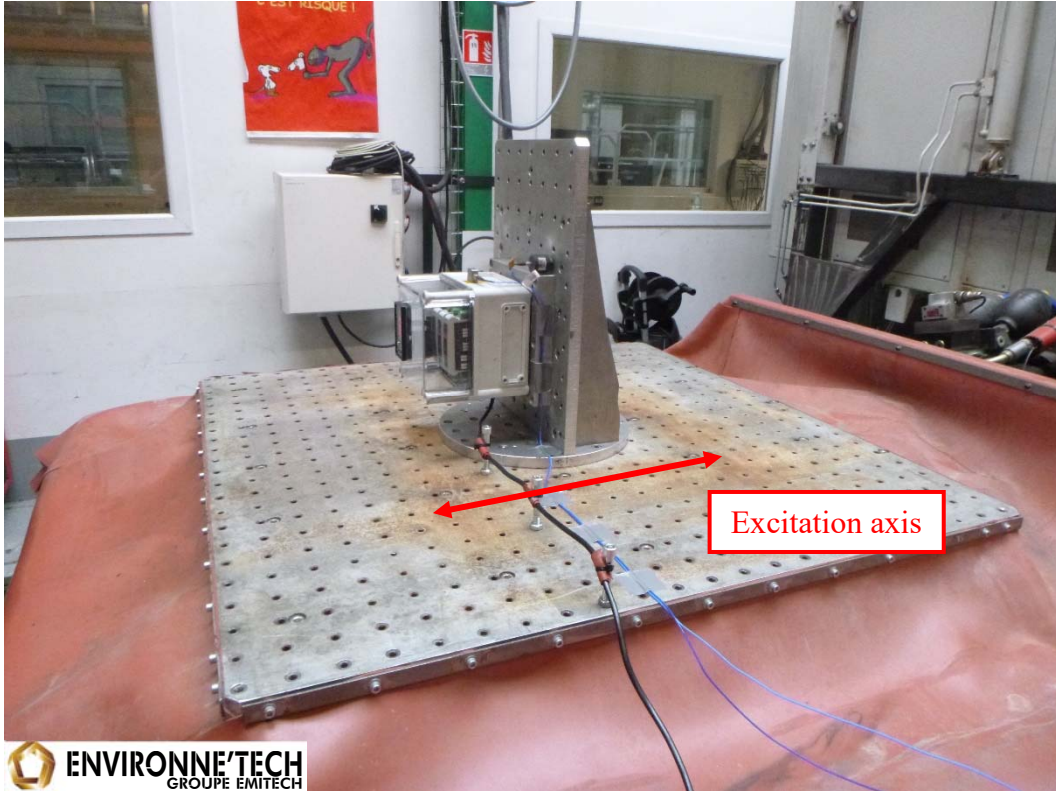

photo 7

LVDT is the displacement sensor of the bench.
Positioning of accelerometers P and M is given below:

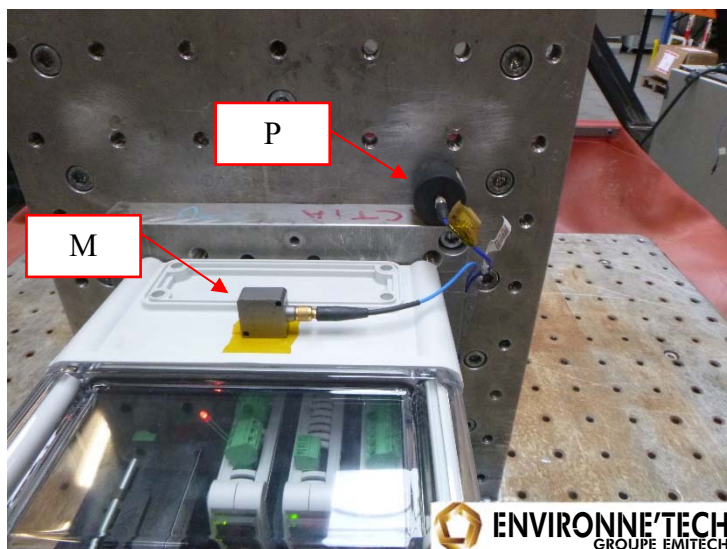
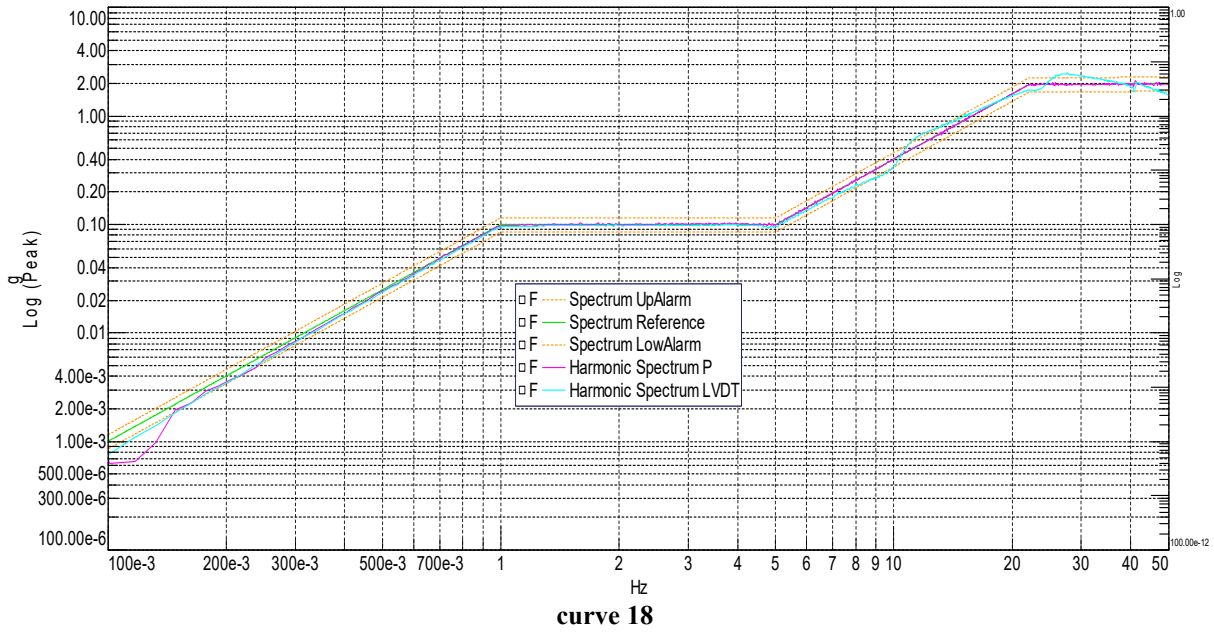

photo 8

5.2.2. Sinus vibrations – RFR initial:

Control curve recorded at test end given below:

Acceleration measurements of P and LVDT sensors are given below:



Displacement measurements of P and LVDT sensors are given below:

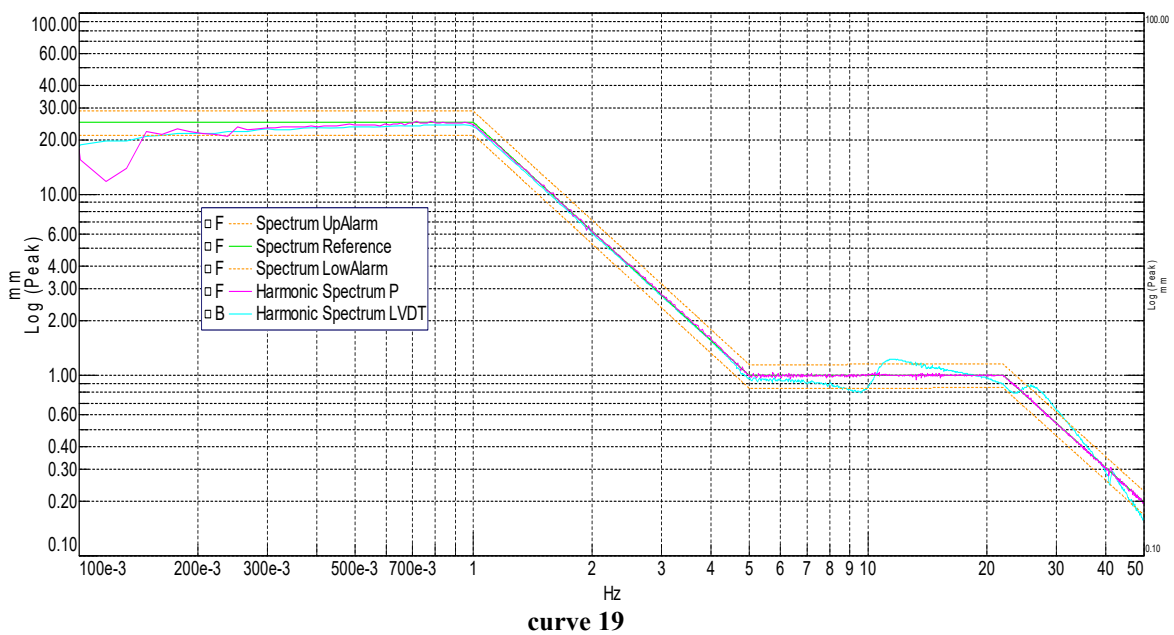

Measurements at M point are given below:

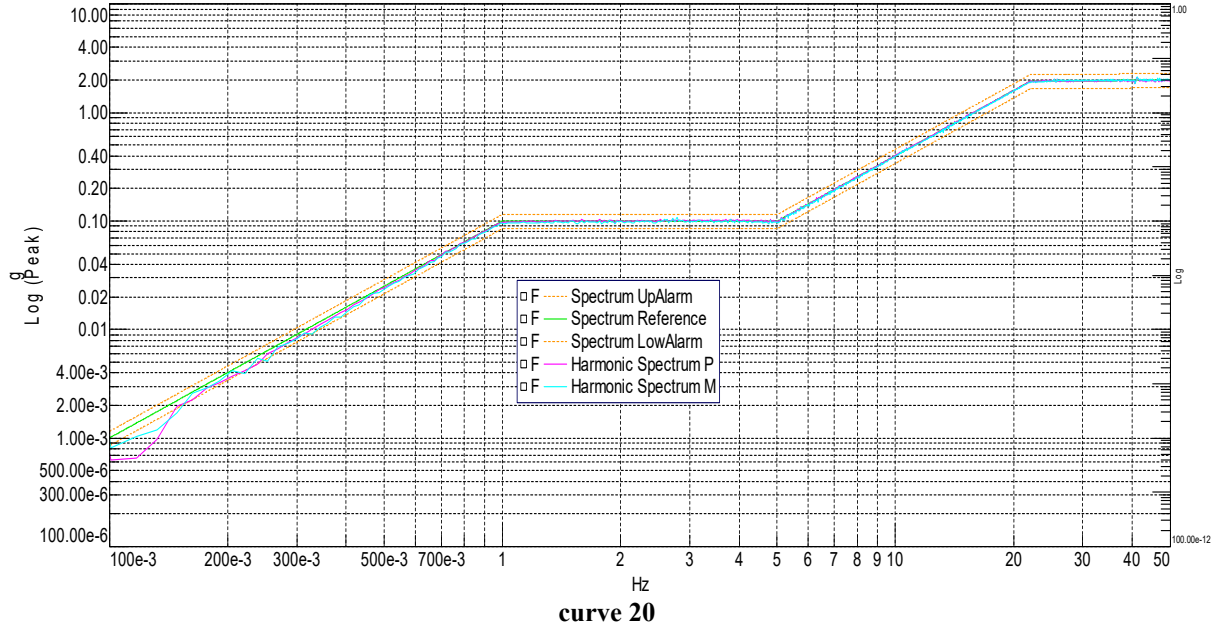

Transfer function at M point is given below:

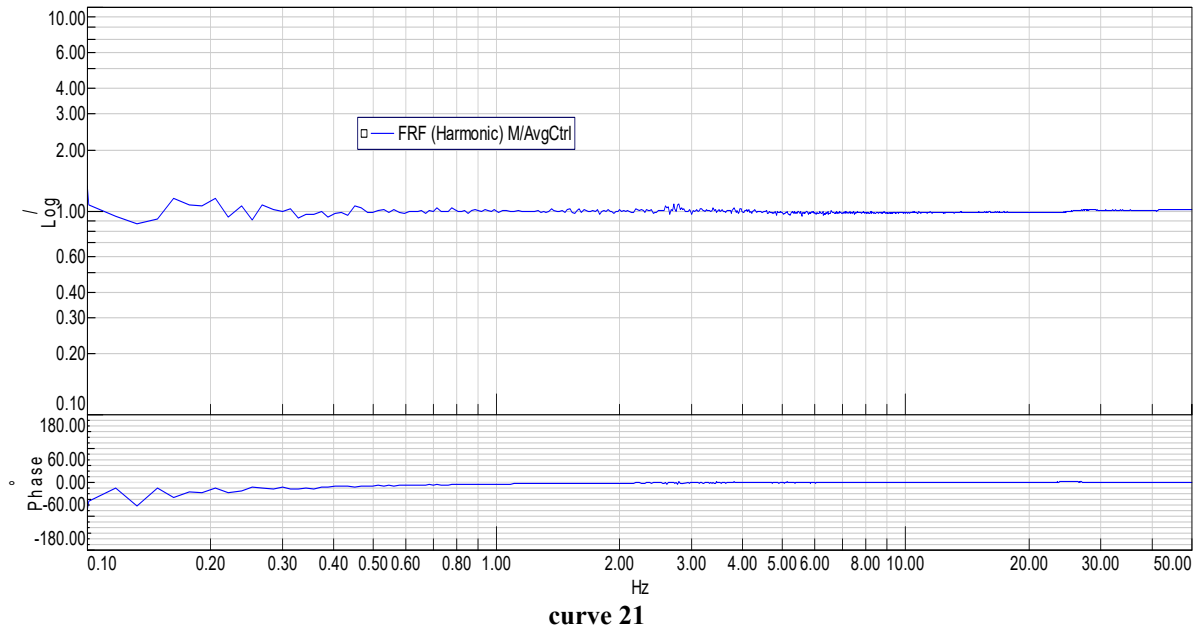

Results: No degradation was observed. There is no resonance frequency.

5.2.3. Sinus vibrations - Endurance:

Control curve recorded at test end given below:

Acceleration measurements of P and LVDT sensors are given below:

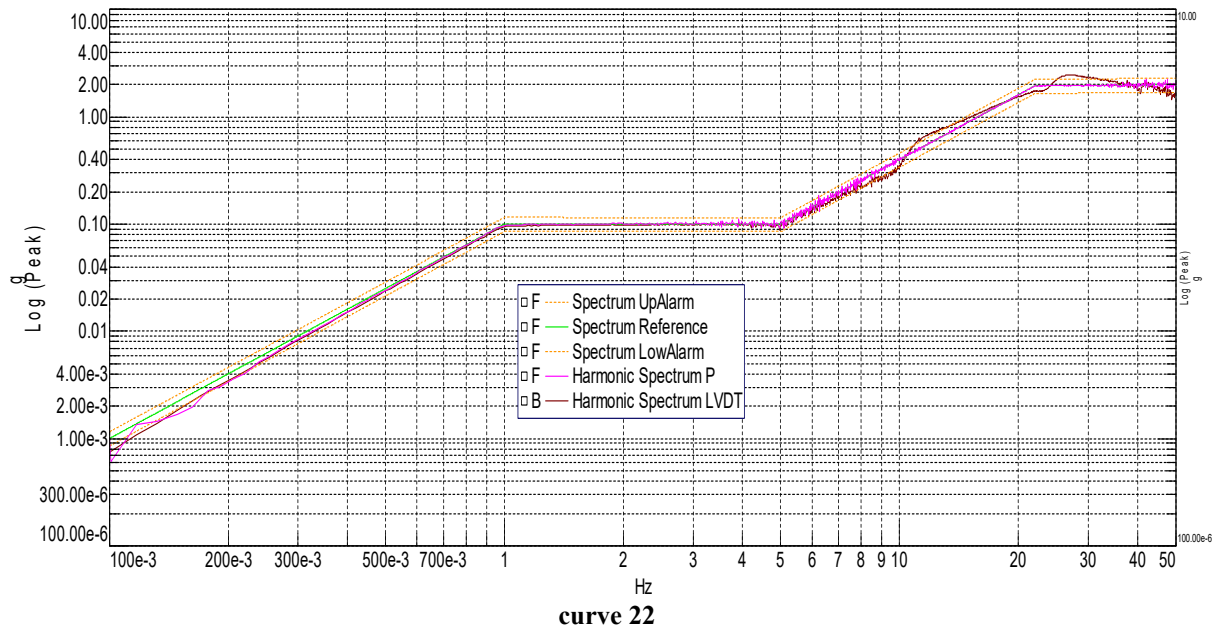

Displacement measurements of P and LVDT sensors are given below:

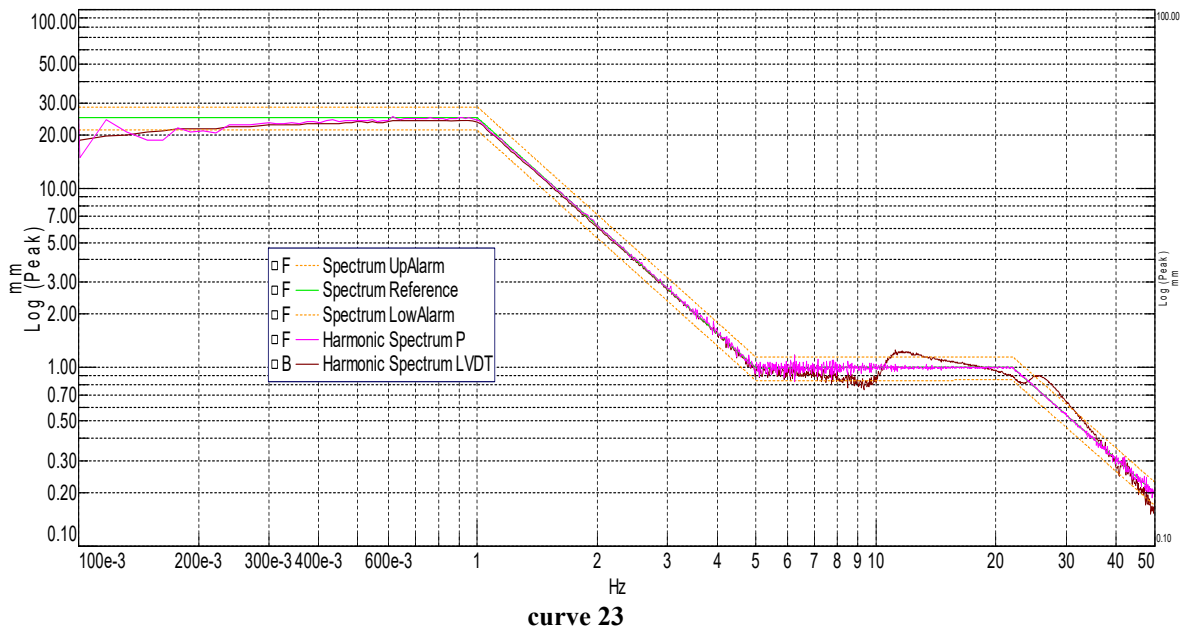

Measurements at M point are given below:

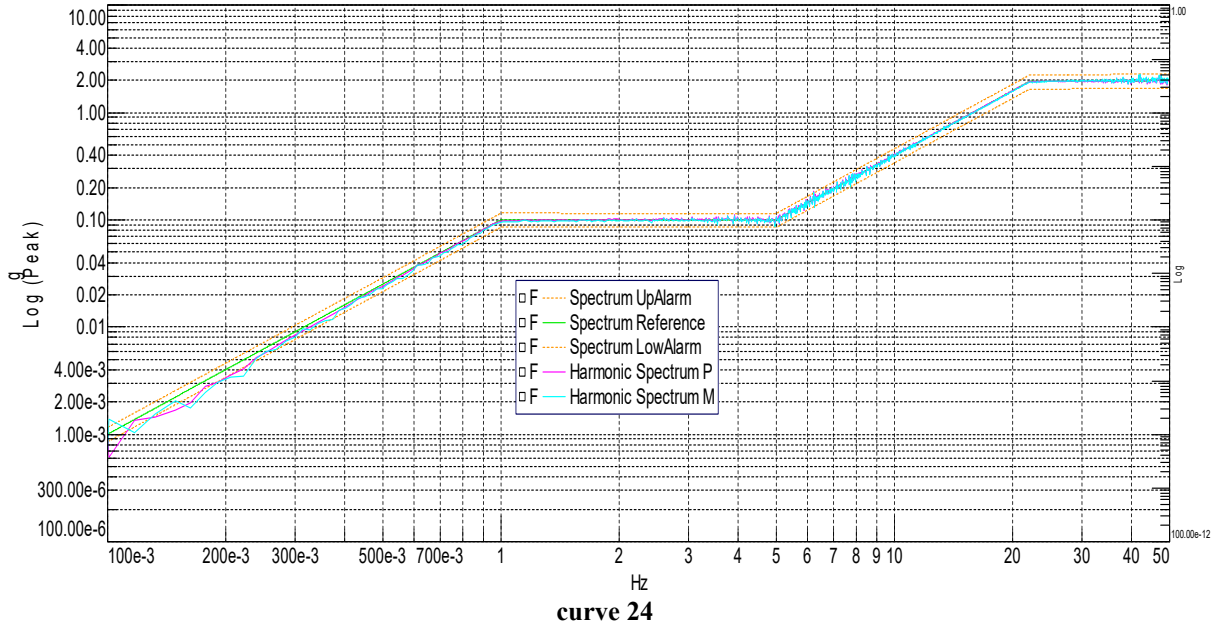

Results: No degradation was observed at the end of the test.

5.2.4. Sinus vibrations – RFR final:

Control curve recorded at test end given below:

Acceleration measurements of P and LVDT sensors are given below:

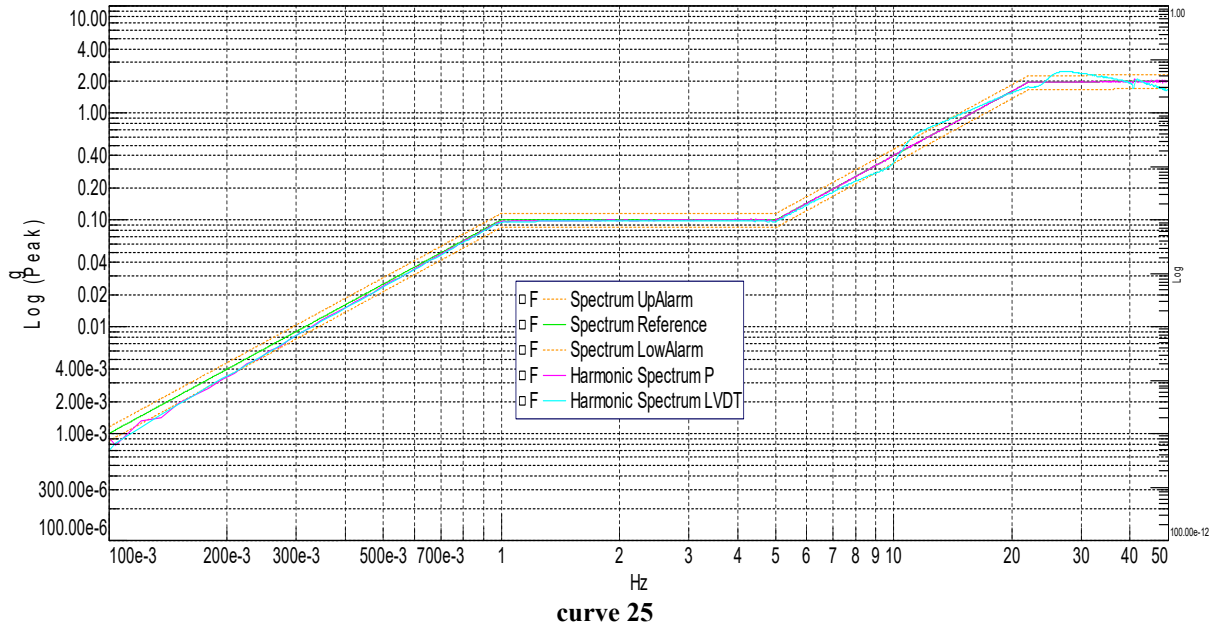

Displacement measurements of P and LVDT sensors are given below:

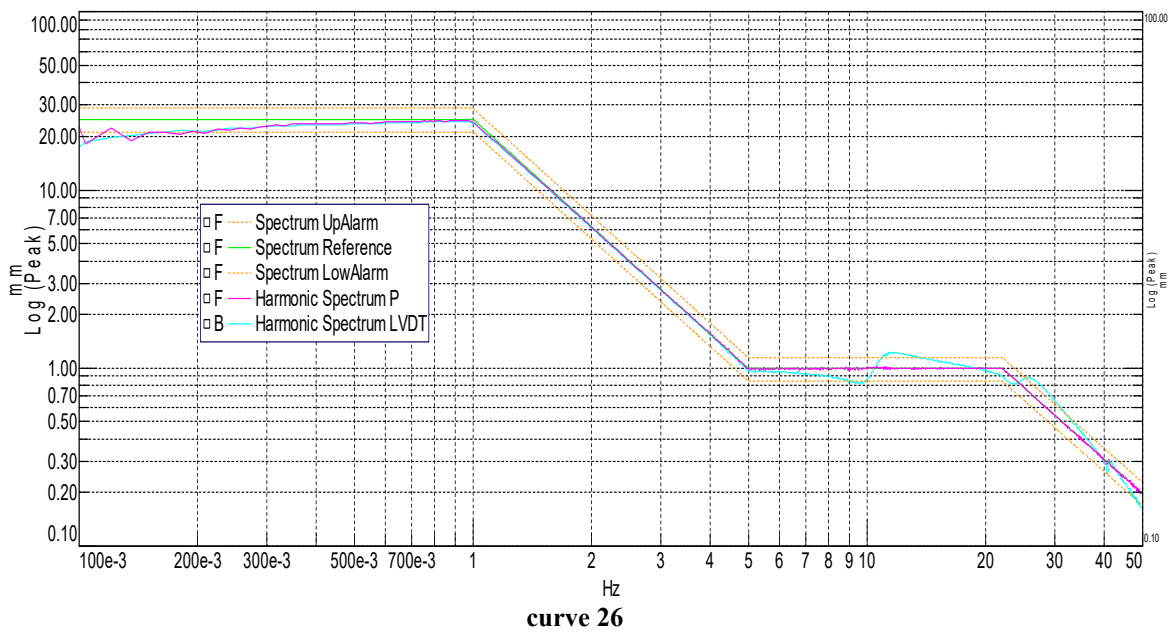

Measurements at M point are given below:

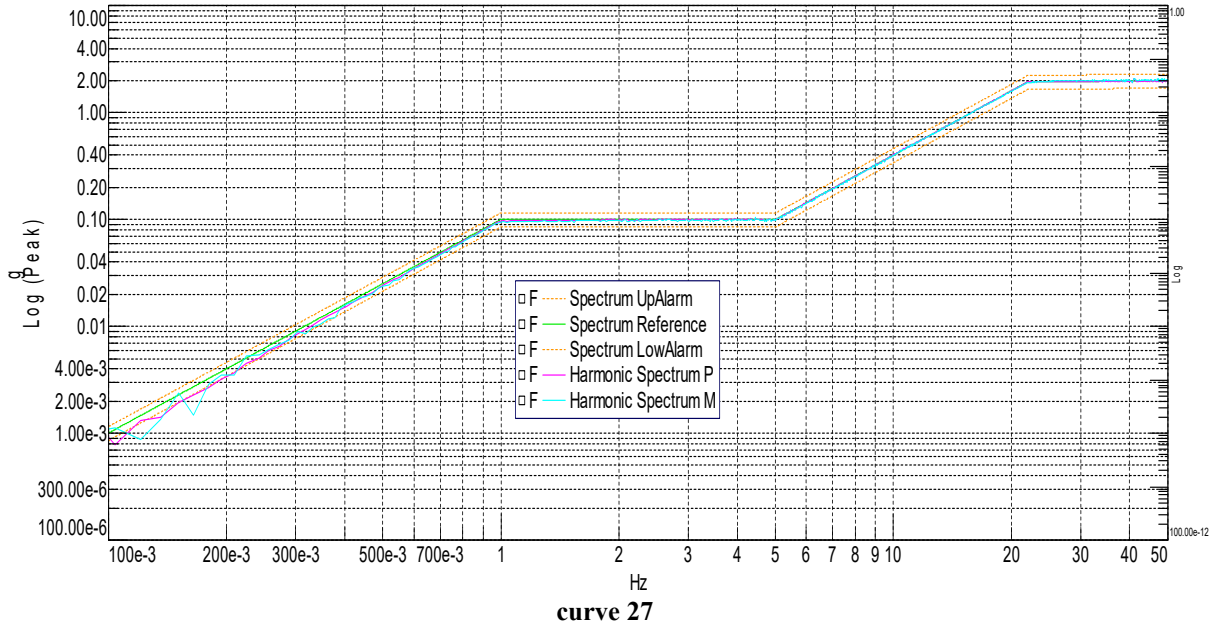

Transfer function at M point is given below:

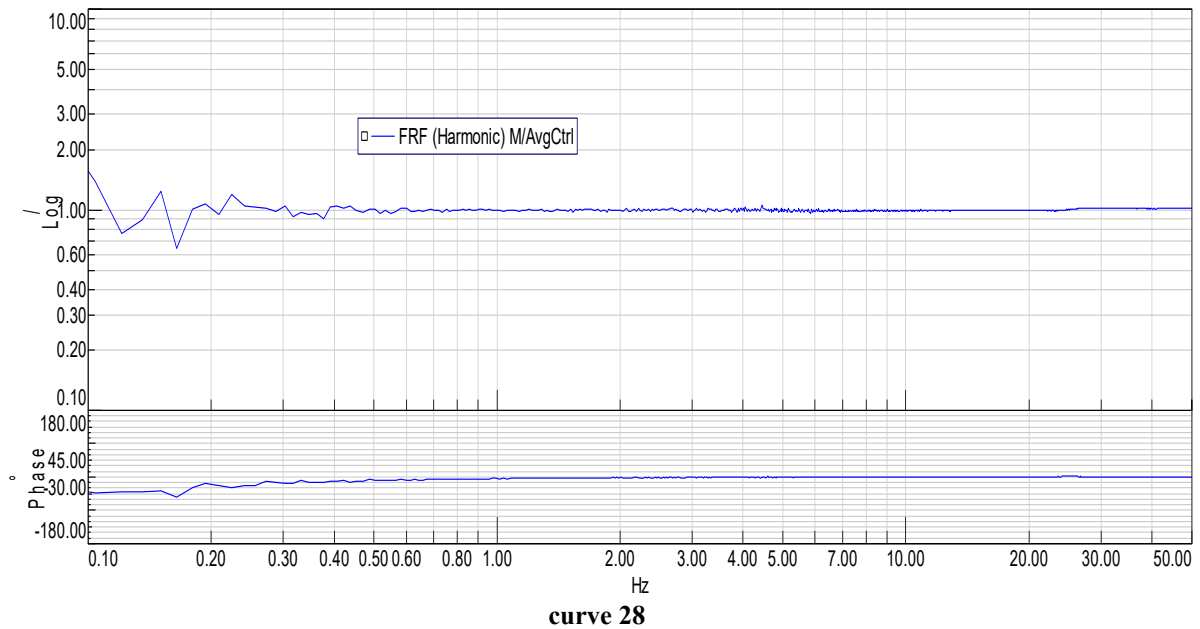

Results: No degradation was observed. There is no resonance frequency.

5.2.5. Test set up for shocks:

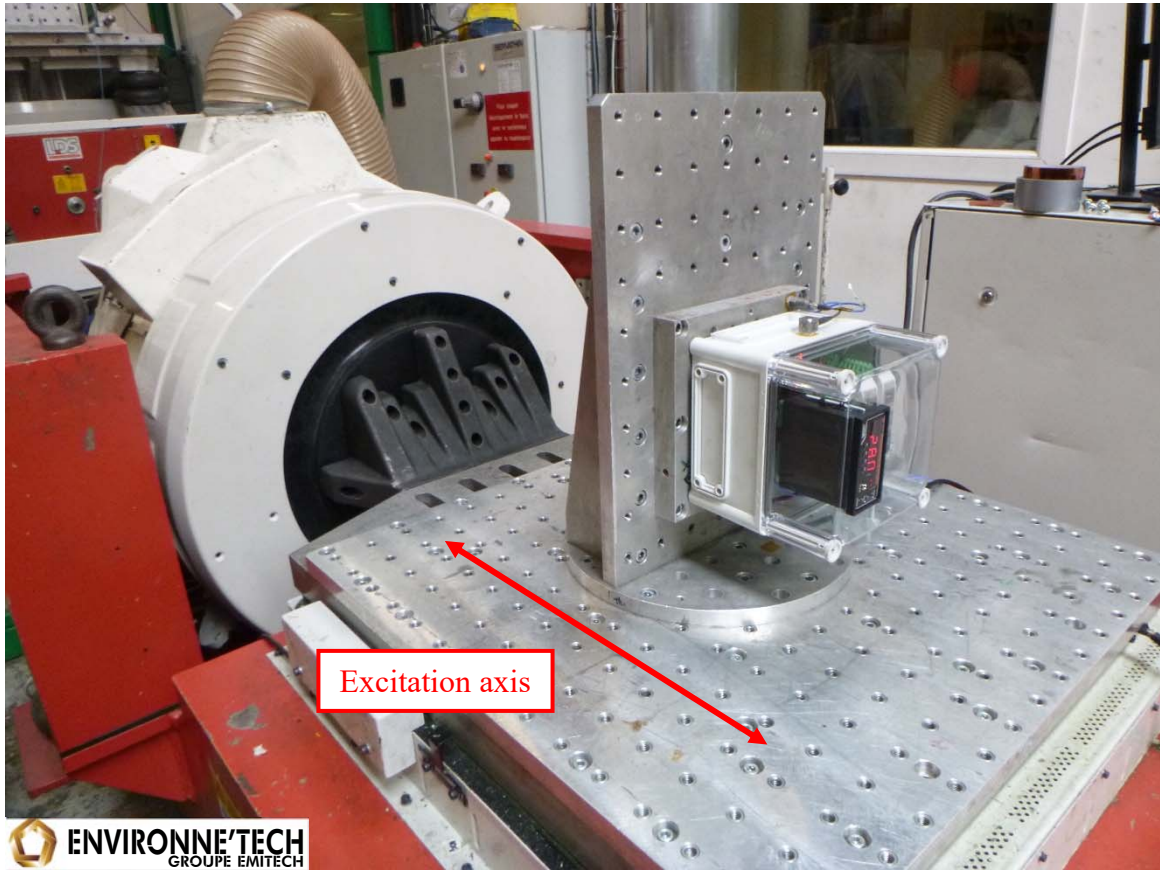

photo 9

Positioning of accelerometers P and M given below:

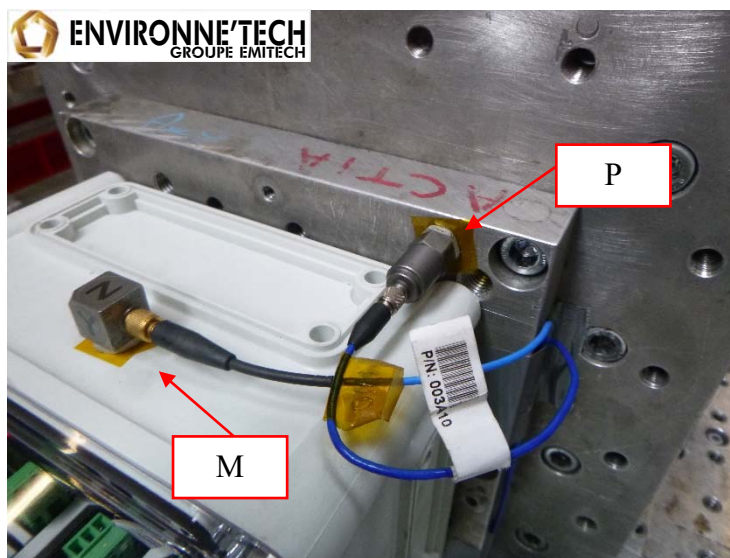

photo 10

5.2.6. Shock tests:

Control was done at P point.

Curve of the third positive shock given below.

Control curve is given below:

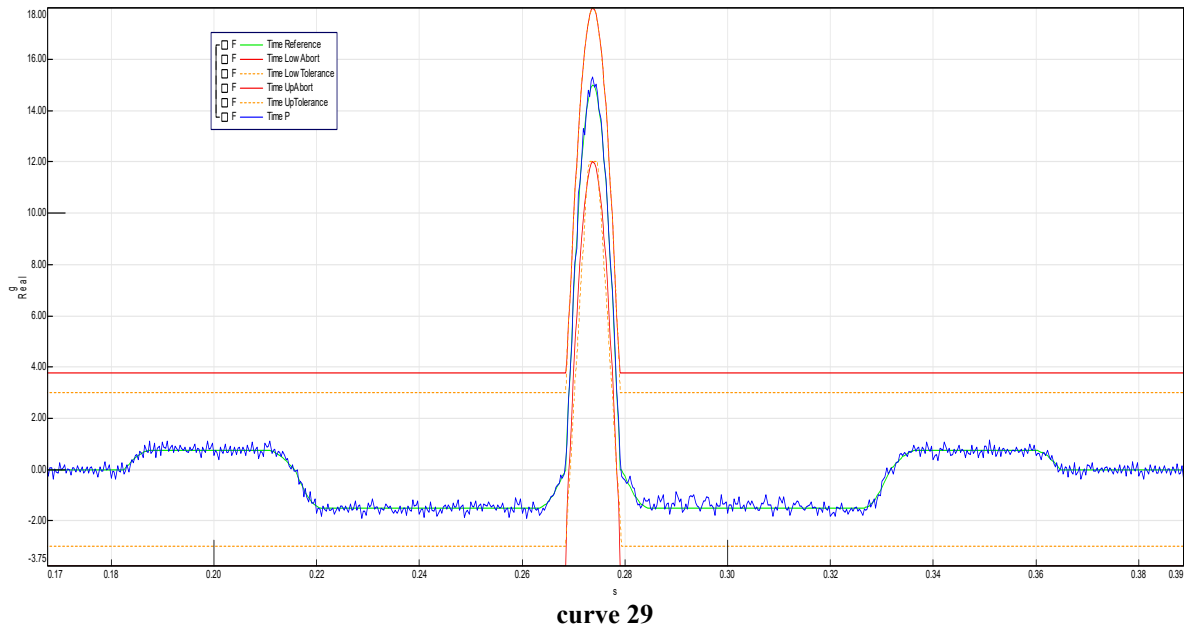

Zoomed control curve is given below:

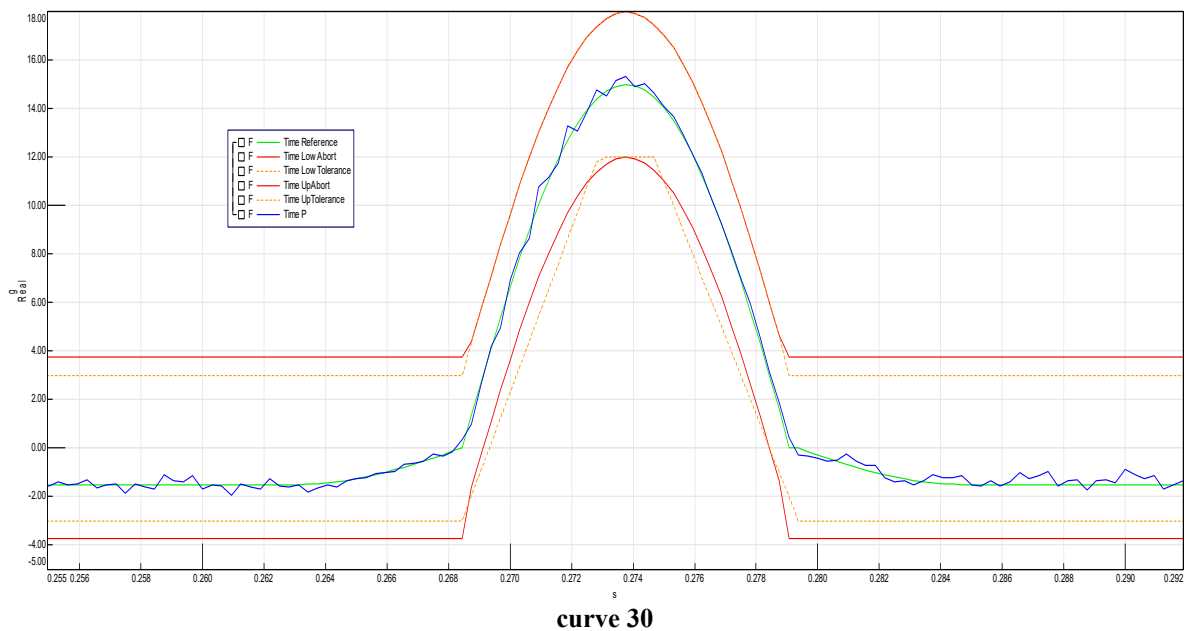

Curves at M point are given below:

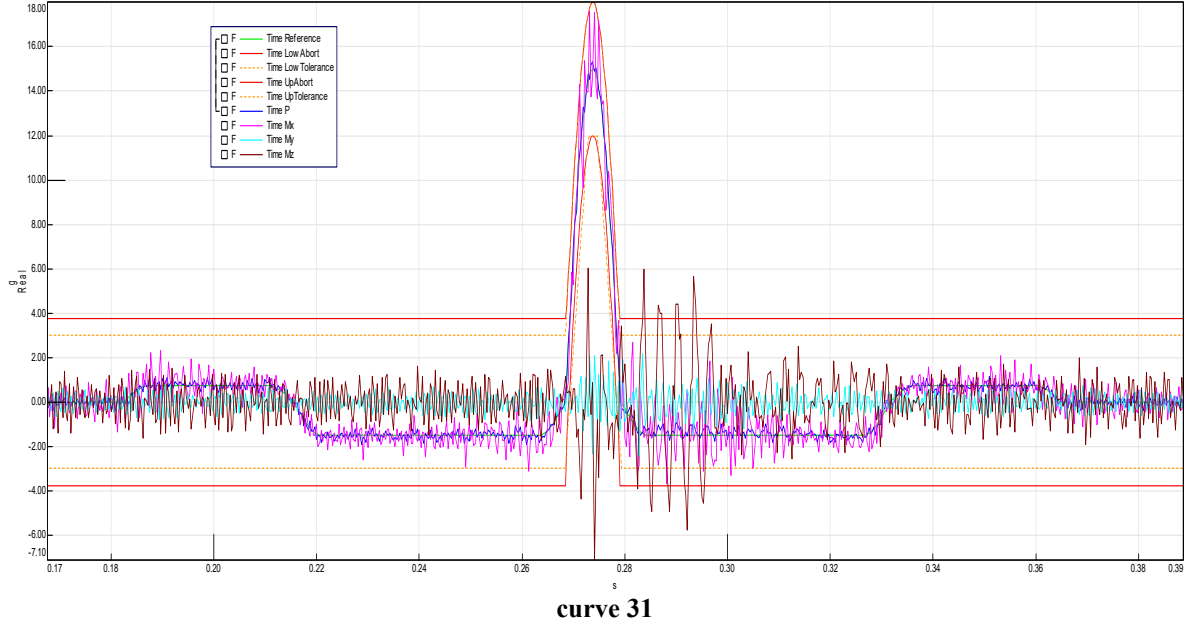

Curve of the third negative shock given below.

Control curve is given below:

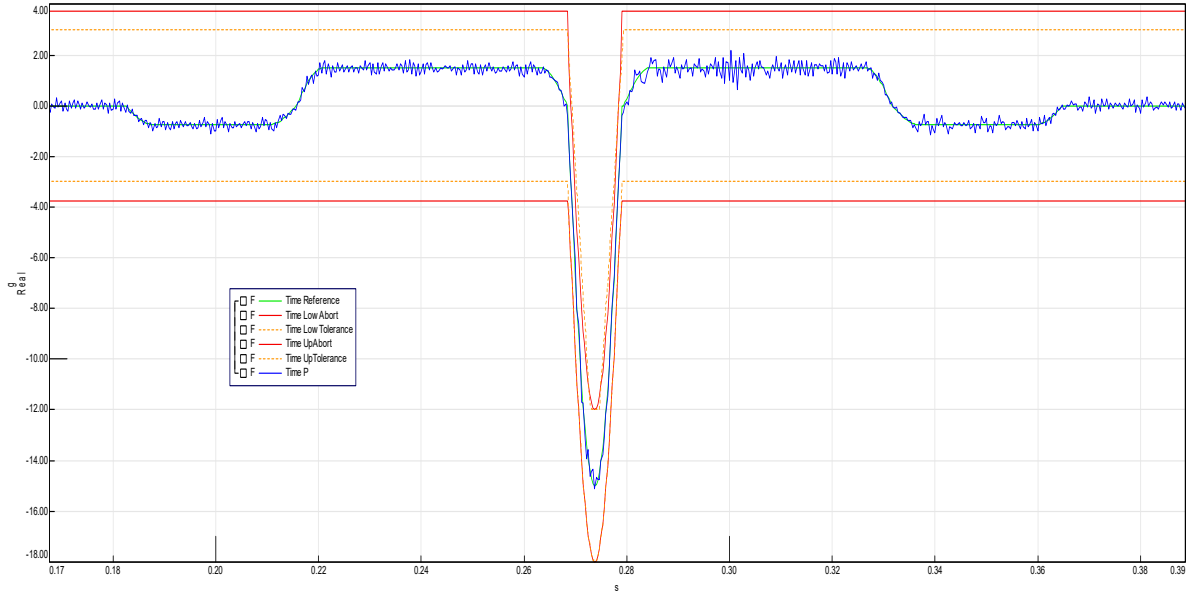

curve 32

Zoomed control curve is given below:

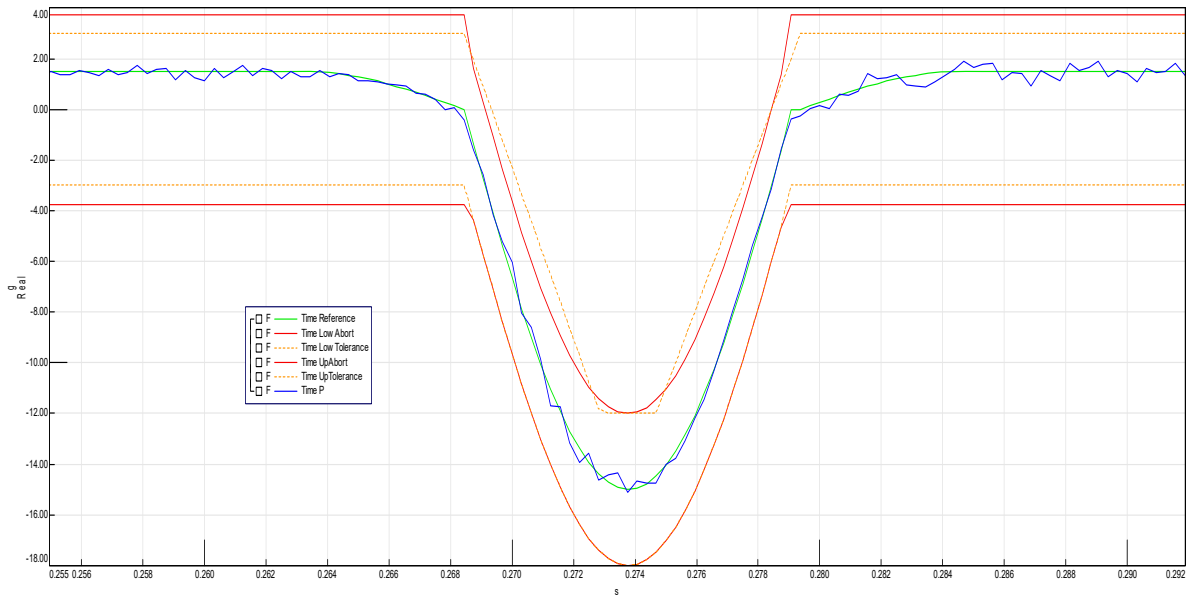

curve 33

Curves at M point are given below:

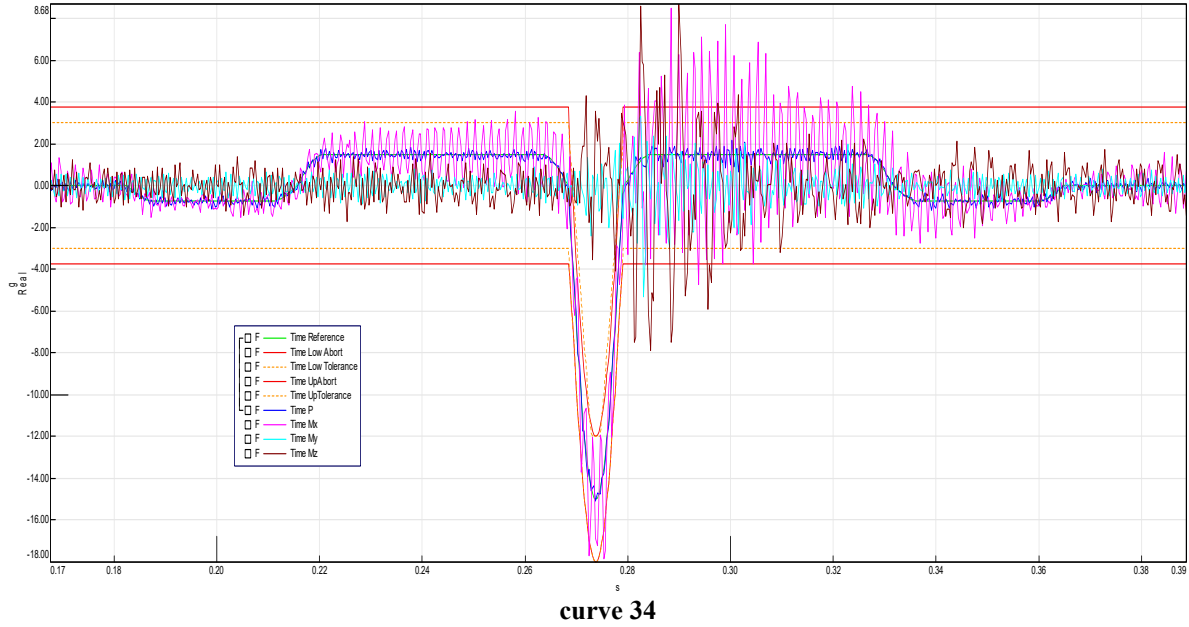

Results: No degradation was observed at the end of the test.

5.3. Y axis:

5.3.1. Test set up for sine vibrations:

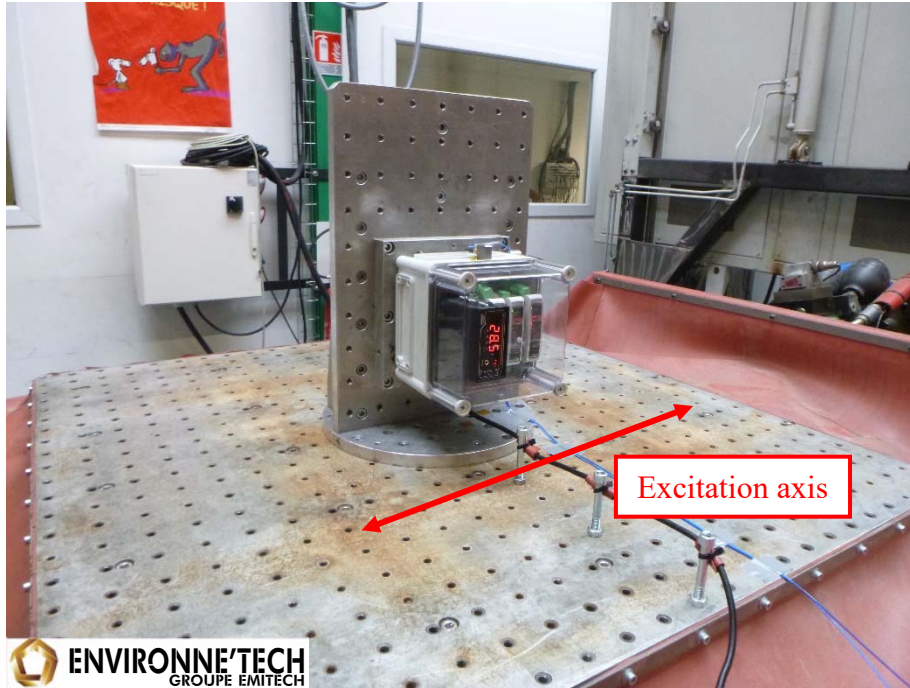

photo 11

LVDT is the displacement sensor of the bench.
Positioning of accelerometers P and M are given below:

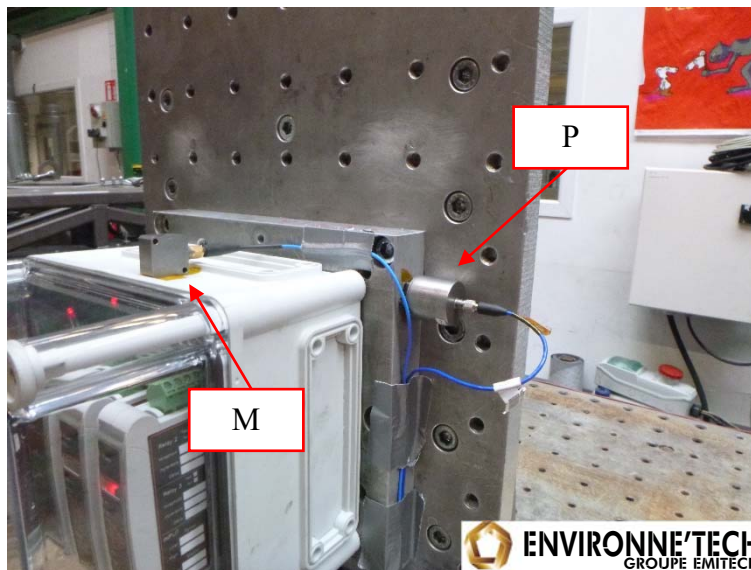
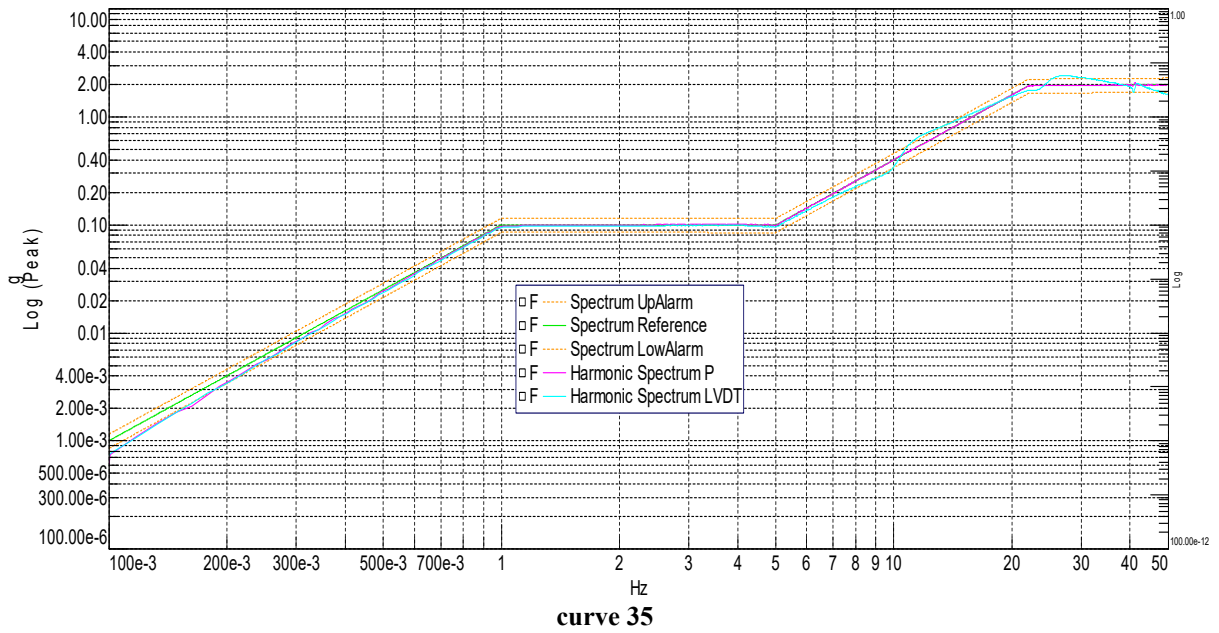

photo 12

5.3.2. Sinus vibrations – RFR initial:

Control curve recorded at test end given below:

Acceleration measurement of P and LVDT sensors:



Displacement measurement of P and LVDT sensors:

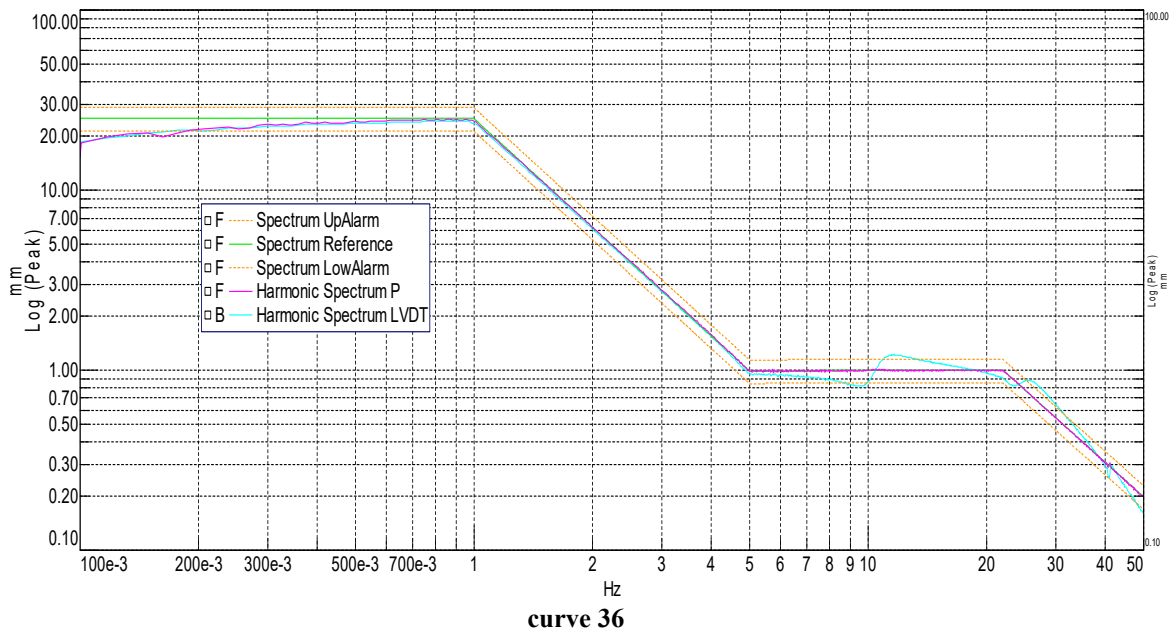

Measurements point given below:

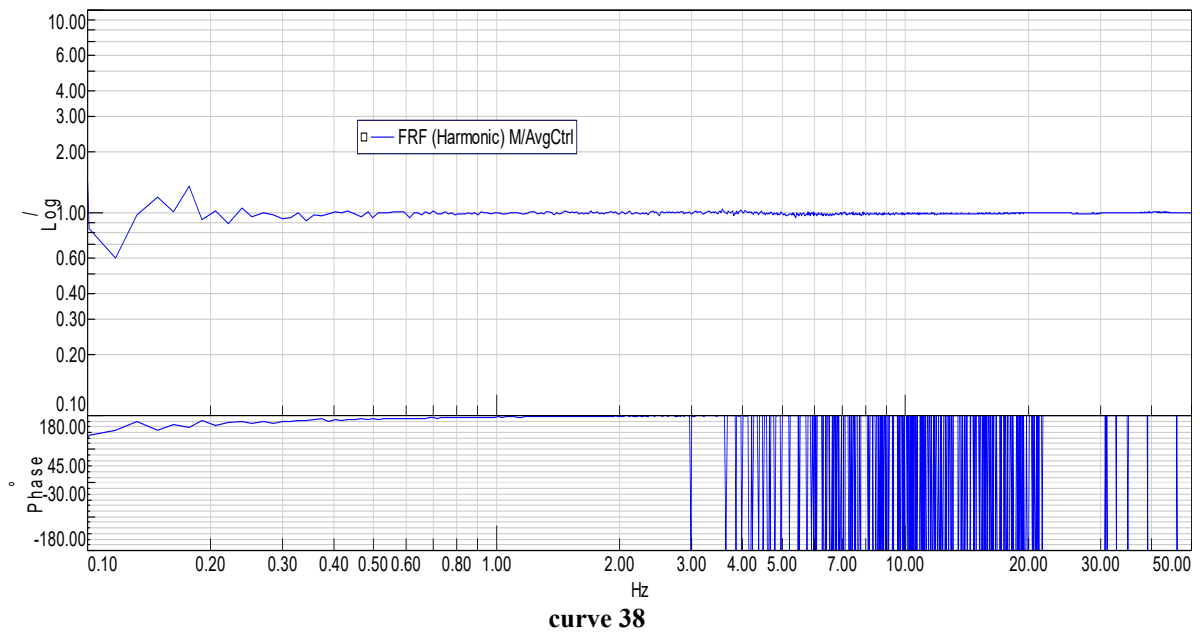
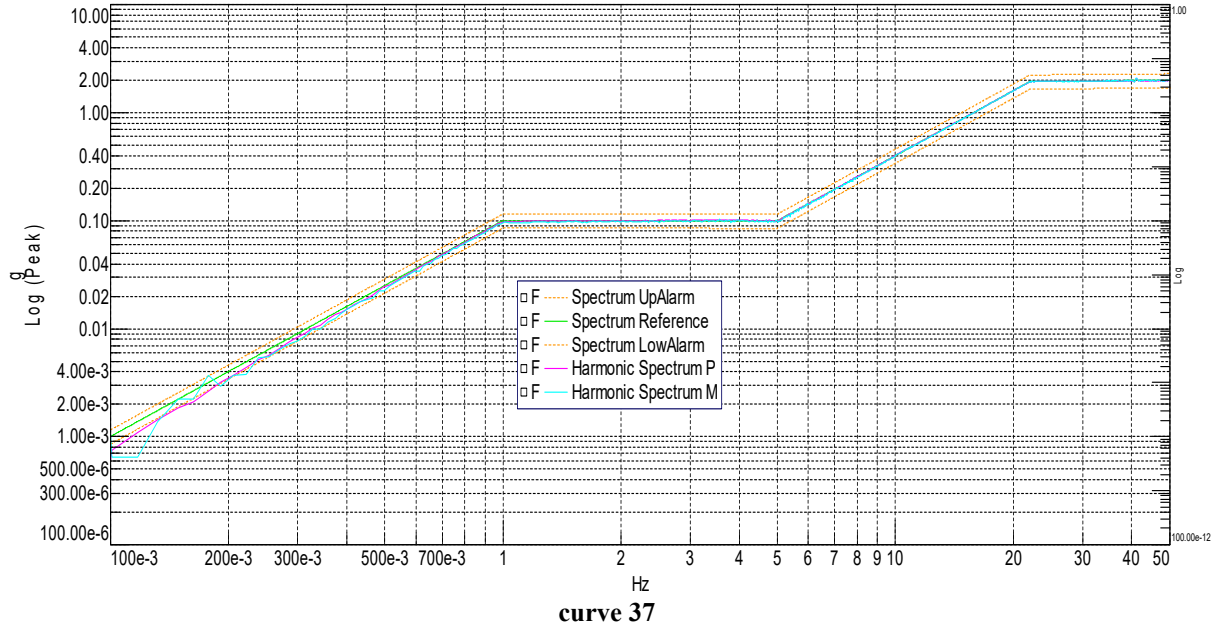

Results: No degradation was observed. There is no resonance frequency.

5.3.3. Sinus vibrations - Endurance:

Control curve recorded at test end given below:

Acceleration measurement of P and LVDT sensors:

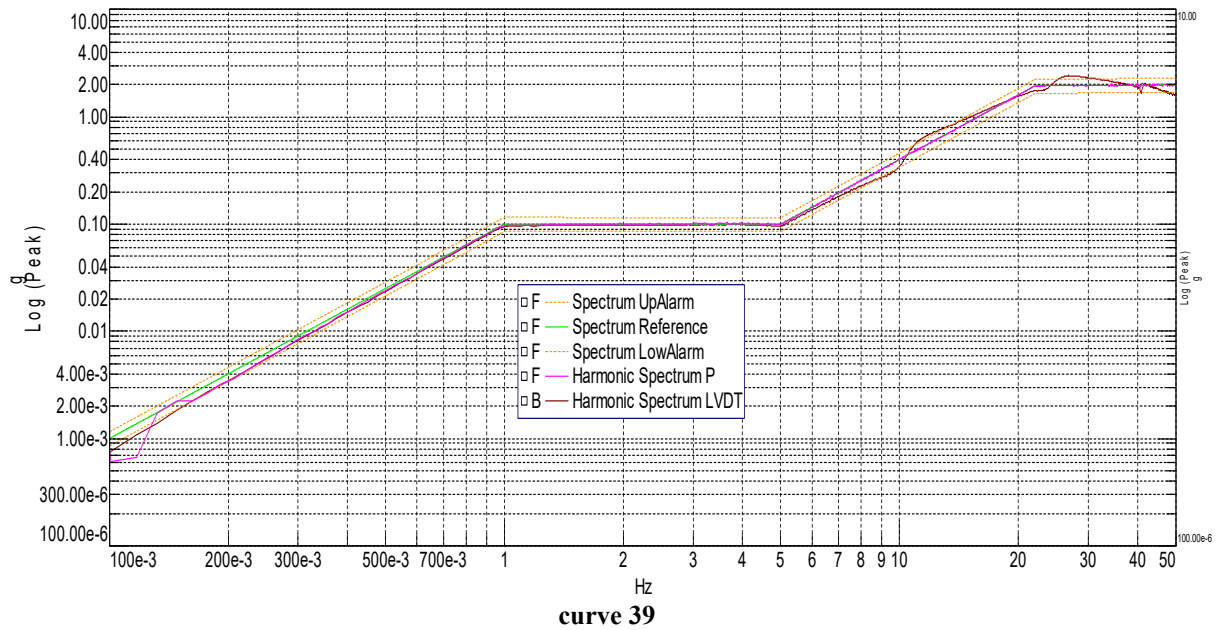

Displacement measurement of P and LVDT sensors are given below:

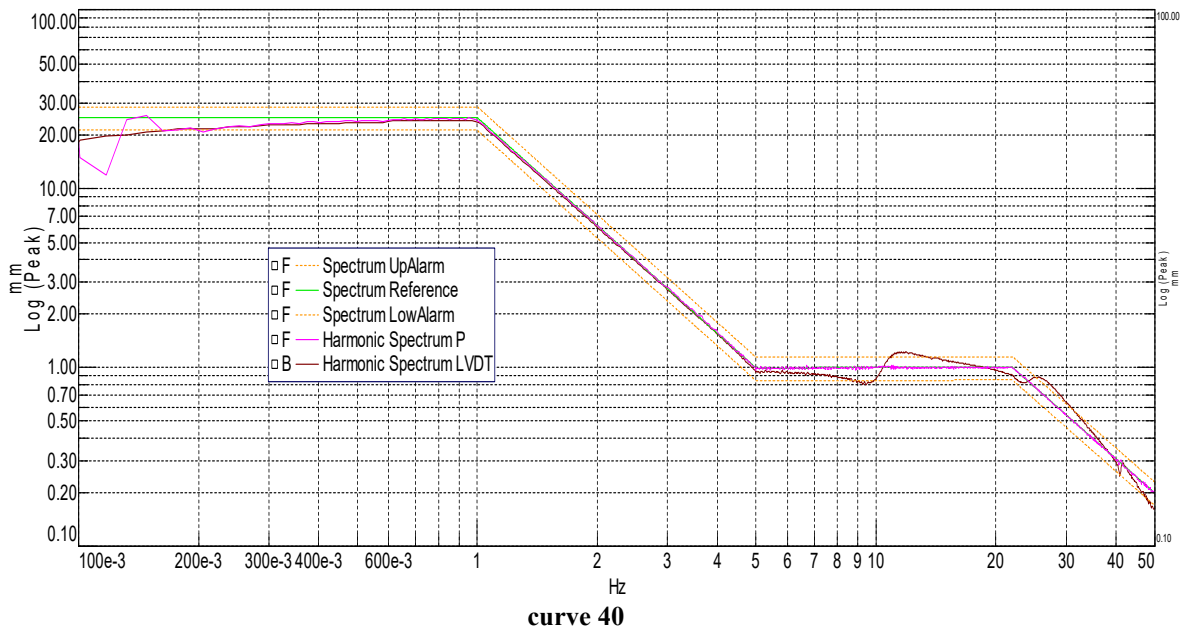

Measurements at M point are given below:

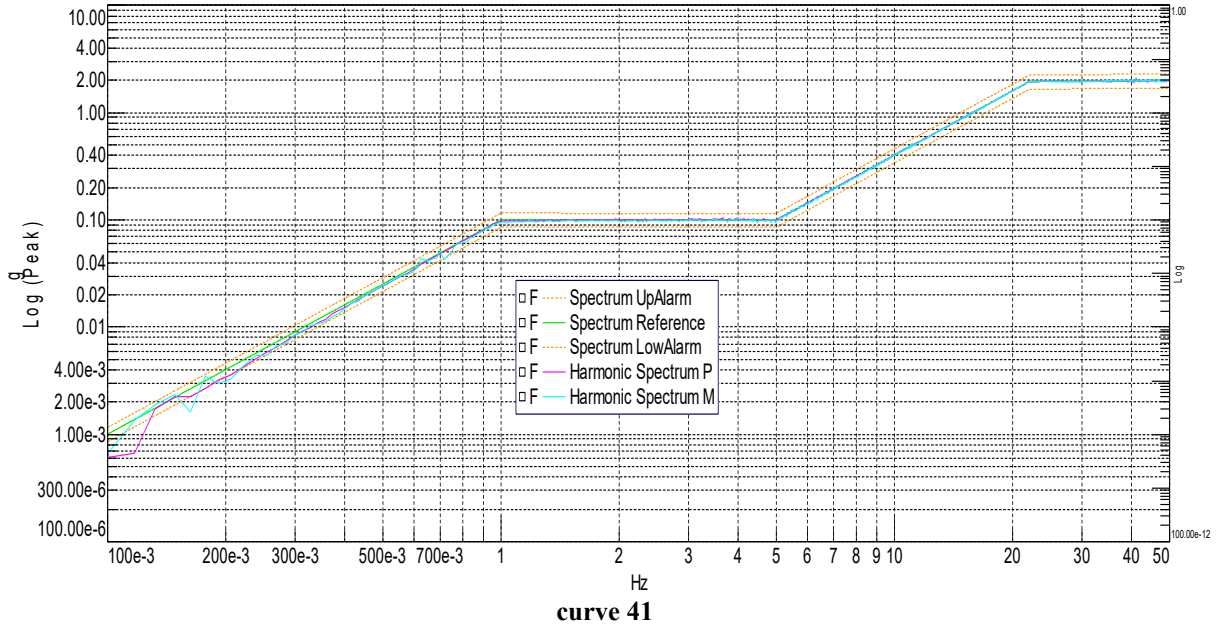

Results: No degradation was observed at the end of the test.

5.3.4. Sinus vibrations – RFR final:

Control curve recorded at test end given below:

Acceleration measurement of P and LVDT sensors are given below:

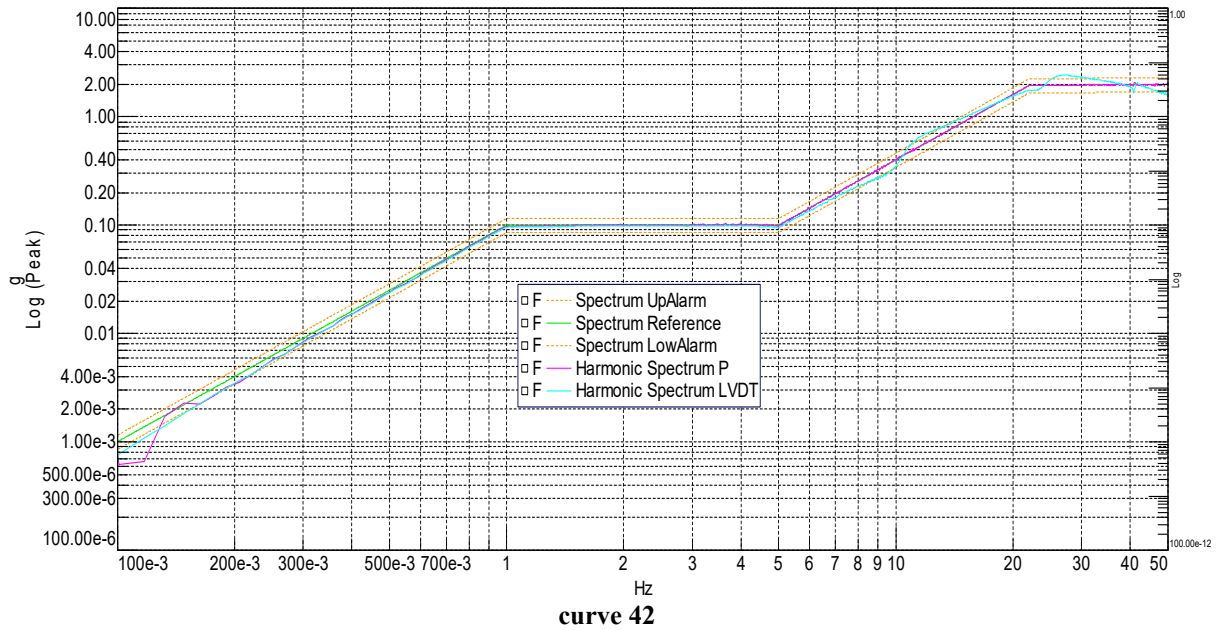

Displacement measurements of P and LVDT sensors are given below:

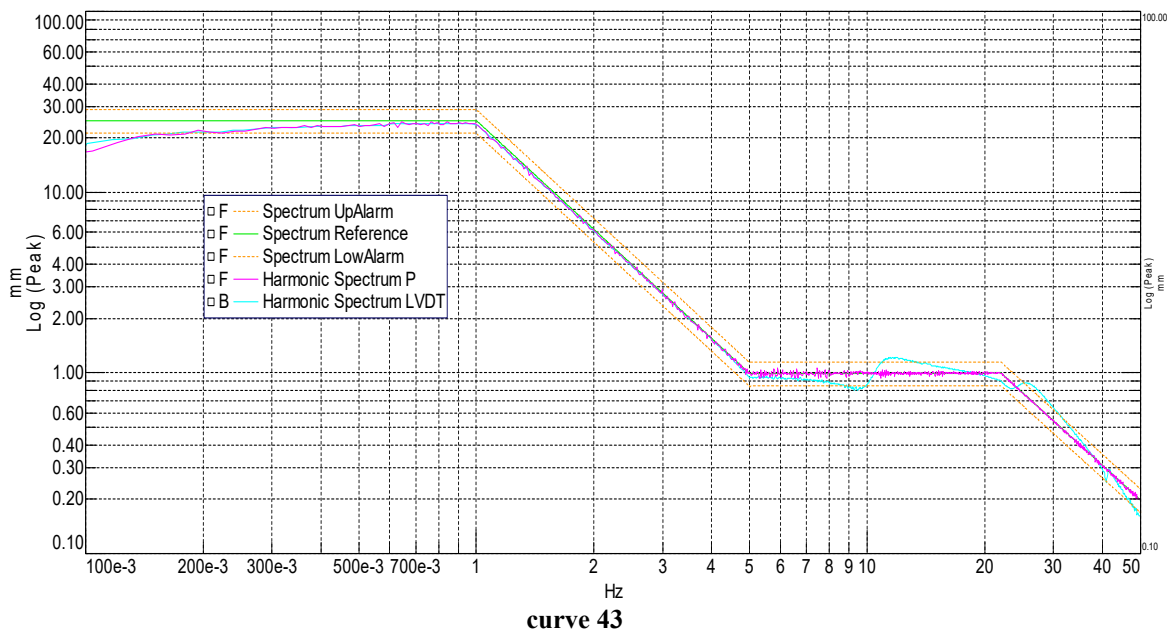

Measurements at M point are given below:

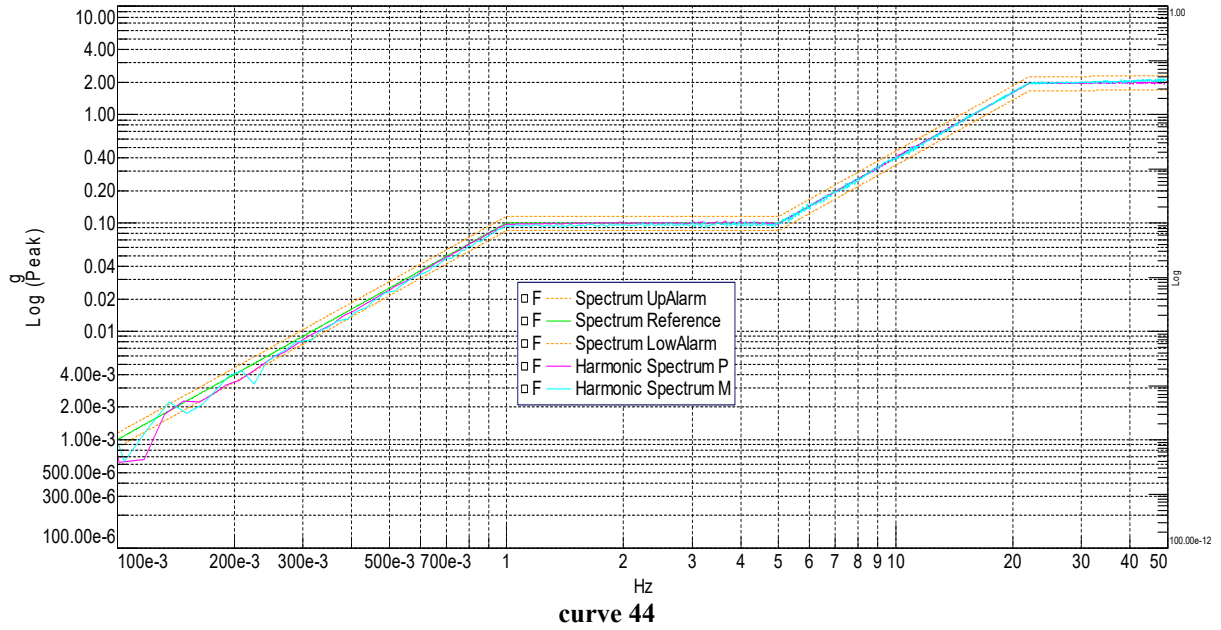

Transfer function of M point is given below:

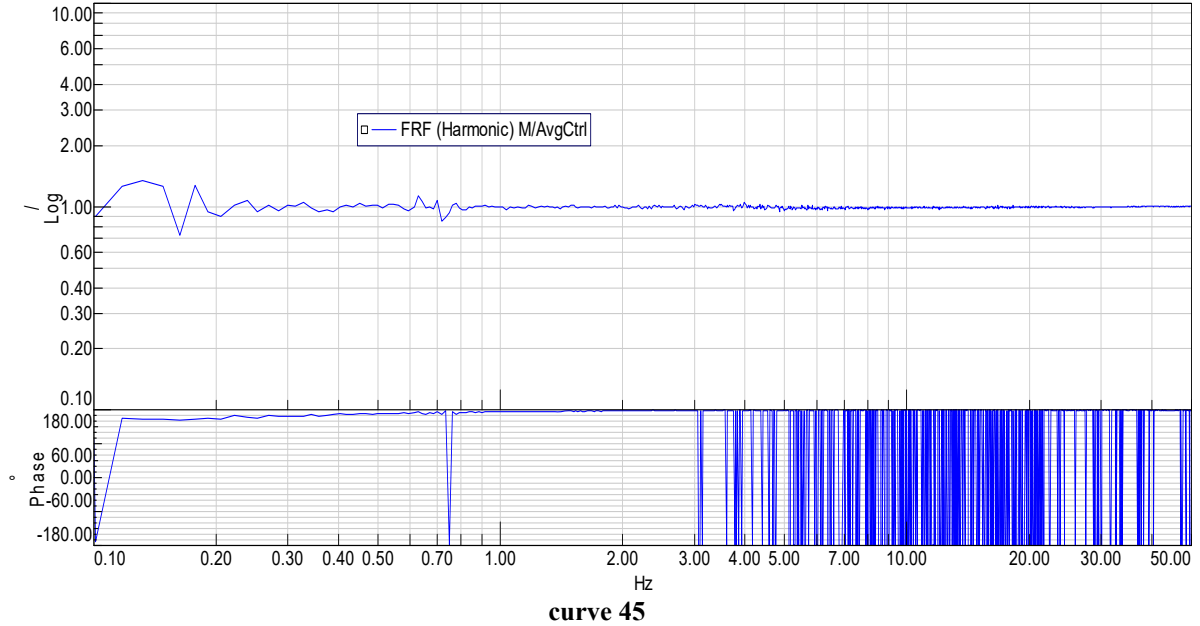

Results: No degradation was observed. There is no resonance frequency.

5.3.5. Test set up for shocks:

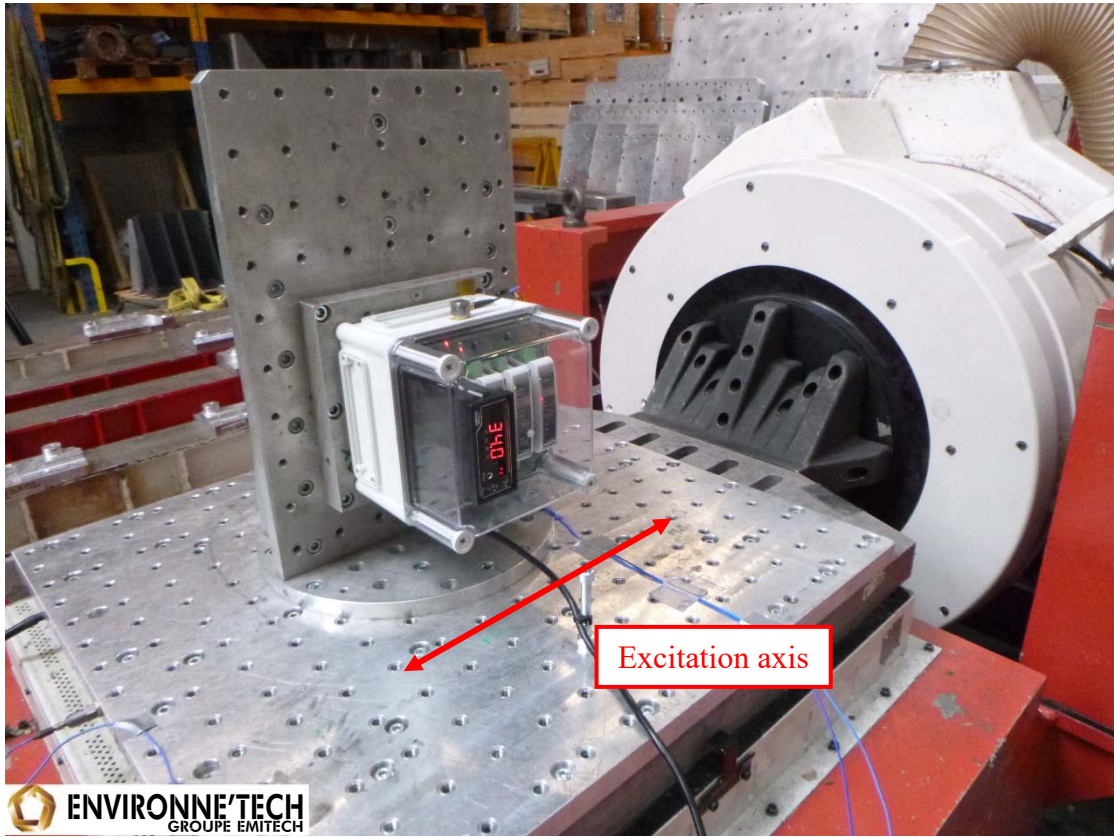

photo 13

Positioning of accelerometers P and M given below:

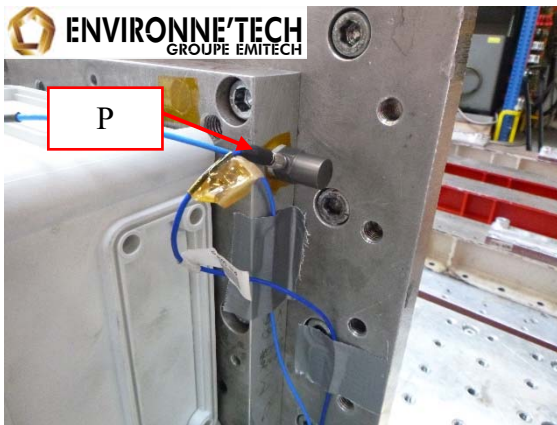

photo 14



photo 15

5.3.6. Shock tests:

Control was done at P point.

Curves of the third positive shock are given below.

Control curve is given below:

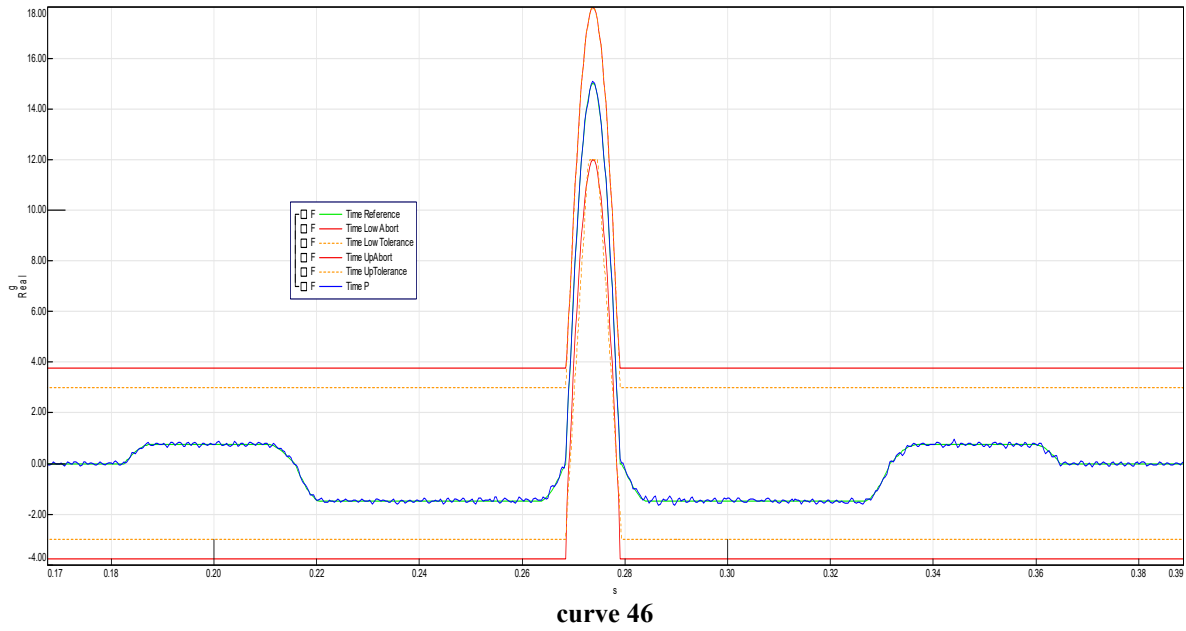

Zoomed control curve is given below:

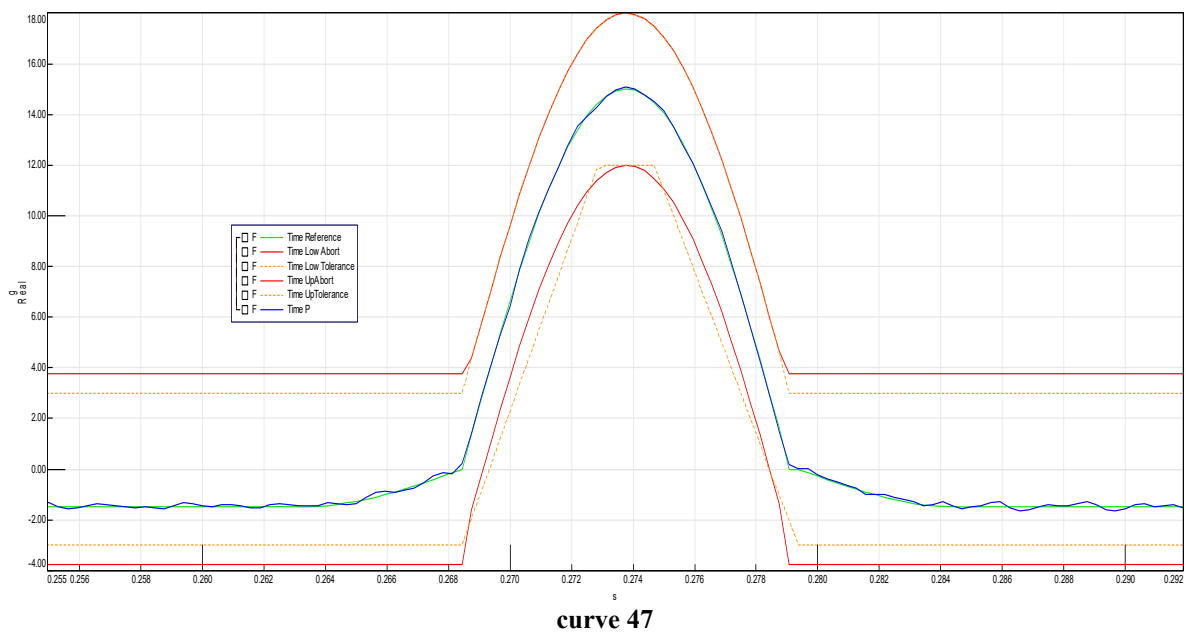

Curves at M point are given below:

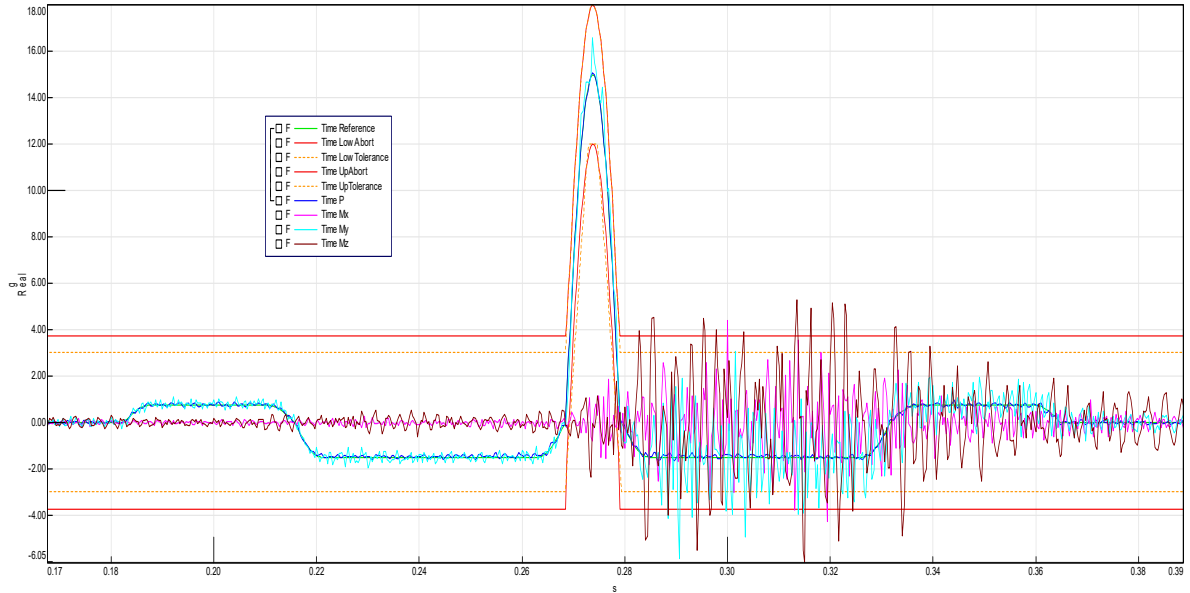

curve 48

Curves of the third negative shock are given below.

Control curve is given below:

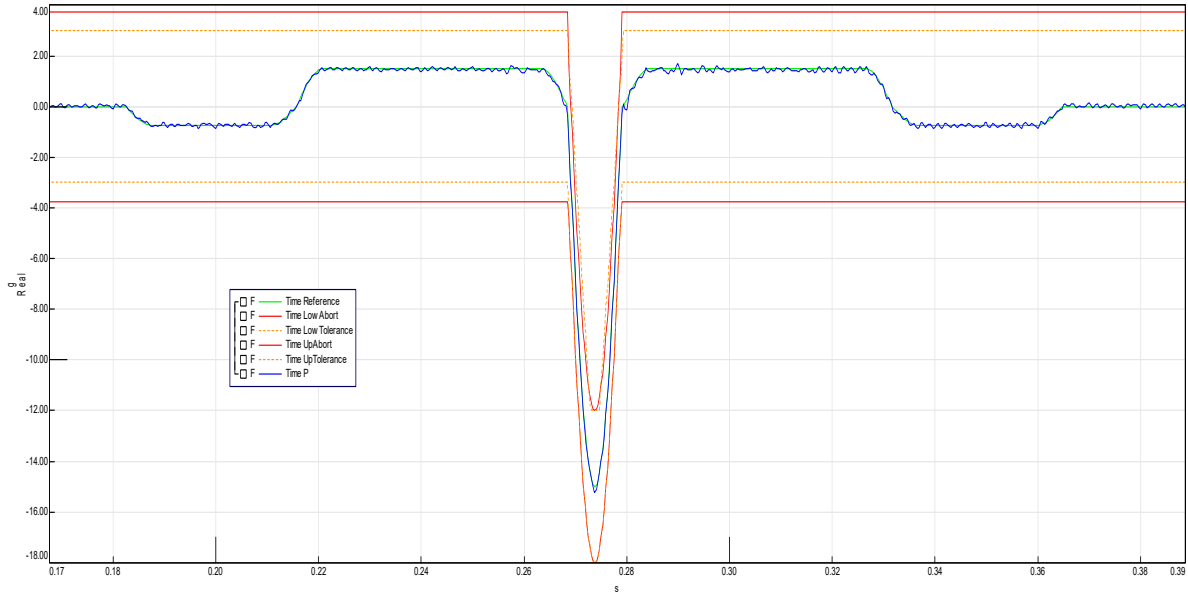

curve 49

Zoomed control curve is given below:

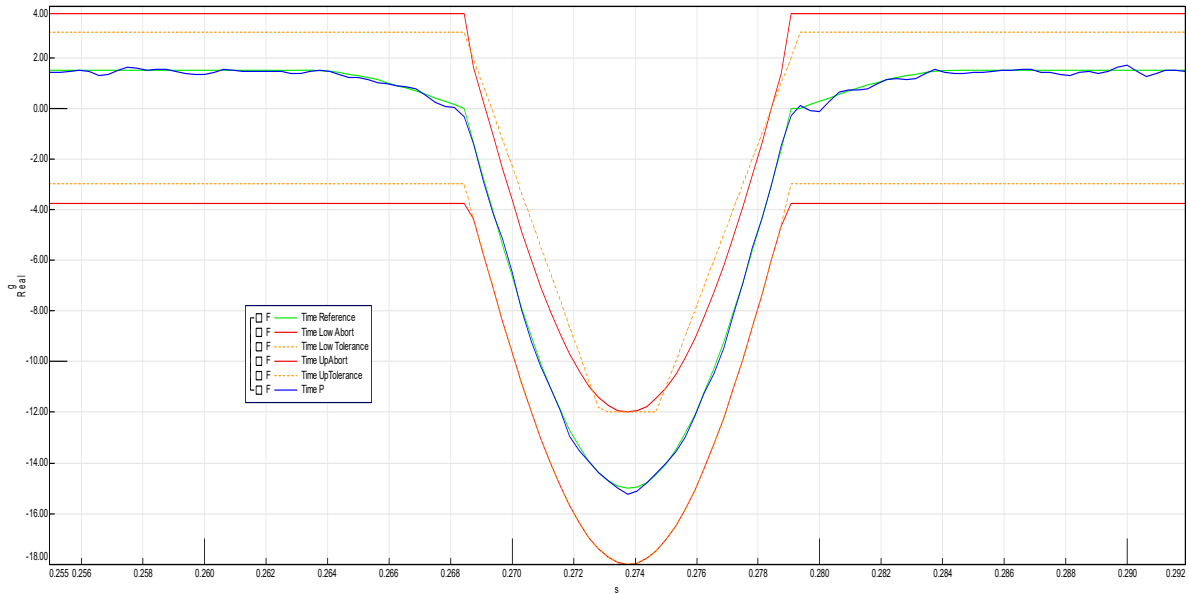

curve 50

Curves at M point are given below:

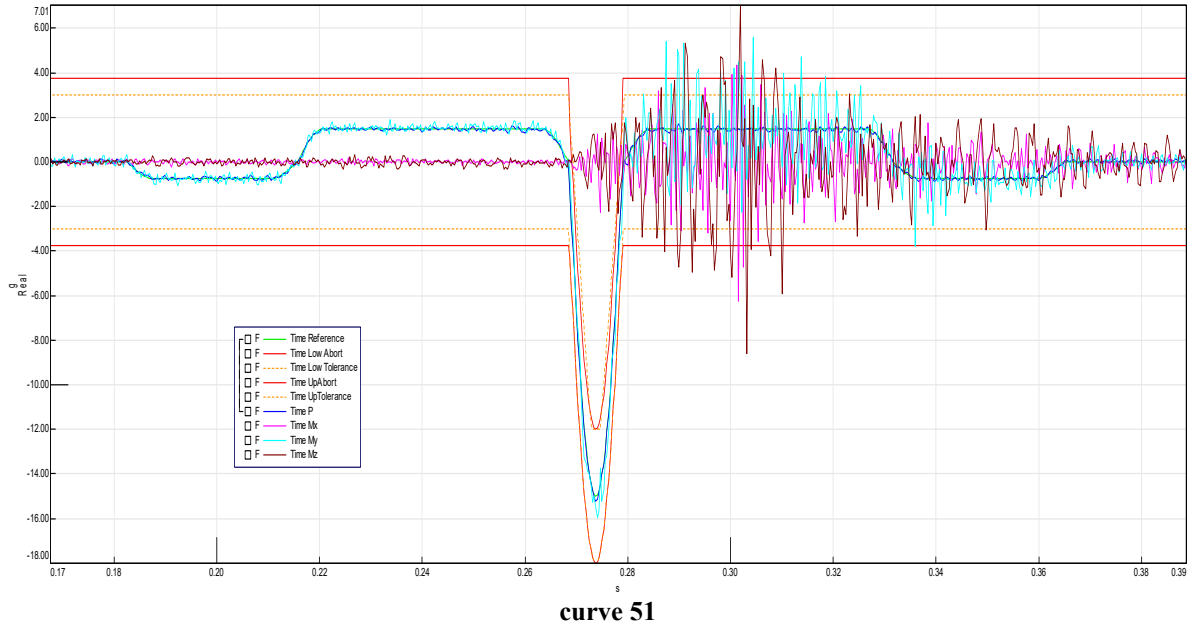

Results: No degradation was observed at the end of the test.

6. CONCLUSION.

Specimen has been tested in accordance with the specifications described in section 3 of this report.

At the end of the tests along Ox axis, no mechanical or functional degradation have been observed.

At the end of the tests along Oy axis, no mechanical or functional degradation have been observed.

At the end of the tests along Oz axis, no mechanical or functional degradation have been observed.

Specimen is returned to the LOREME Company for final expertise.

□□□ End of report □□□